

# brother

**Embroidery Design Guide**

**Stickmuster-Katalog**

**Guide de motifs de broderie**

**Borduurontwerpen**

**bedieningshandleiding**

**Guida ai ricami**

**Guía de diseños  
de bordado**

**Guia de desenhos  
de bordado**



## Note

- Please read Terms of Use for various Embroidery Patterns in Operation Manual before using.
- Embroidery time and size of each design in this guide may differ from the information on the machine display. Please use for reference purpose only.

## Hinweis

- Bitte lesen Sie vor Gebrauch die Nutzungshinweise für die verschiedenen Stickmuster, die Sie in der Bedienungsanleitung finden.
- Die Stickzeit und die Größe jedes Designs in dieser Anleitung können von den Informationen im Display abweichen. Bitte verwenden Sie die Angaben nur als Referenz.

## Remarque

- Veuillez lire les conditions d'utilisation de divers motifs de broderie dans le manuel d'instructions avant toute utilisation.
- La durée de broderie et la taille de chaque motif présenté dans ce guide peuvent différer des informations affichées à l'écran de la machine. Merci de les utiliser à titre de référence uniquement.

## Opmerking

- Lees, voorafgaand aan het gebruik, de gebruiksvoorwaarden voor de verschillende borduurpatronen in de bedieningshandleiding.
- De informatie in deze handleiding over de borduurtijd en de afmeting van het borduurpatroon kan afwijken van de weergave op het beeldscherm van de machine. Gelieve de informatie alleen te gebruiken als richtlijn.

## Nota

- Leggere le Condizioni d'uso dei vari ricami nel Manuale di istruzioni prima dell'uso.
- Il tempo di ricamo e le dimensioni di ciascun ricamo in questa guida possono differire dalle informazioni sul display della macchina. Si prega di utilizzare solo come riferimento.

## Nota

- Lea las condiciones de uso de los distintos patrones de bordado en el Manual de instrucciones antes de su uso.
- El tiempo de bordado y el tamaño de cada diseño en esta guía pueden diferir de la información en la pantalla de la máquina. Por favor, use solo como referencia.

## OBSERVAÇÃO

- Leia os Termos de Uso para vários padrões de bordado no Manual de Operações antes de operar a máquina.
- O tempo e o tamanho do bordado de cada desenho neste guia podem ser diferentes das informações exibidas na tela da máquina. Use apenas para fins de referência.

## Contents

- 2 Summary of Embroidery Patterns
- 15 Embroidery Patterns Color Change Table
- 44 Examples of Combinations
- 46 Create 3D embroidery
- 47 Font Name Chart

## Inhalt

- 2 Übersicht der Stickmuster
- 15 Stickdesign-Farbtabelle
- 44 Kombinationsbeispiele
- 46 Erstellen von 3D-Stickereien
- 47 Tabelle der Schriftarten

## Table des matières

- 2 Sommaire des motifs de broderie
- 15 Tableau de changement de couleur des motifs de broderie
- 44 Exemples de combinaisons
- 46 Créez une broderie 3D
- 47 Tableau des noms de polices

## Inhoudsopgave

- 2 Overzicht van borduurpatronen
- 15 Kleurenvorgorde voor de borduurontwerpen
- 44 Voorbeelden van combinaties
- 46 Creëer 3D-borduurwerk
- 47 Overzicht lettertypen

## Sommario

- 2 Riepilogo dei ricami
- 15 Tabella dei cambi colore dei ricami
- 44 Esempi di combinazioni
- 46 Creare ricami 3D
- 47 Tabella nomi dei font

## Contenido

- 2 Resumen de diseños de bordado
- 15 Tabla de cambios de color para diseños de bordado
- 44 Ejemplos de combinaciones
- 46 Crear bordados en 3D
- 47 Diagrama de nombre de las fuentes

## Índice

- 2 Resumo dos padrões de bordado
- 15 Tabela de alteração de cor do padrão de bordado
- 44 Exemplos de combinações
- 46 Criar bordados 3D
- 47 Quadro de nomes de fontes

Summary of Embroidery Patterns  
 Sommaire des motifs de broderie  
 Riepilogo dei ricami  
 Resumo dos padrões de bordado

Übersicht der Stickmuster  
 Overzicht van borduurpatronen  
 Resumen de diseños de bordado

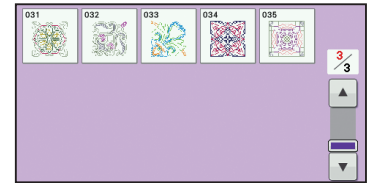
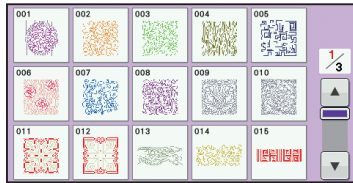
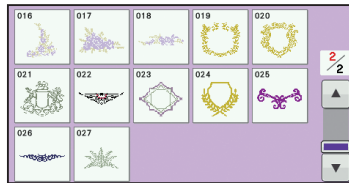
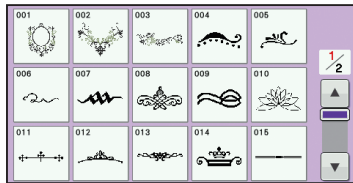
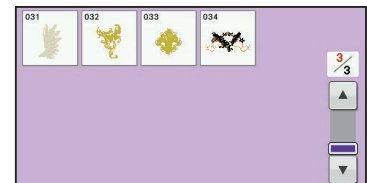
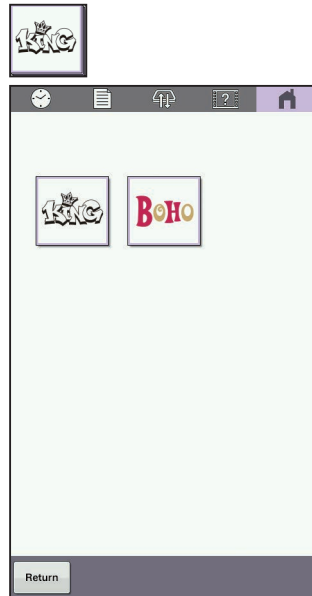
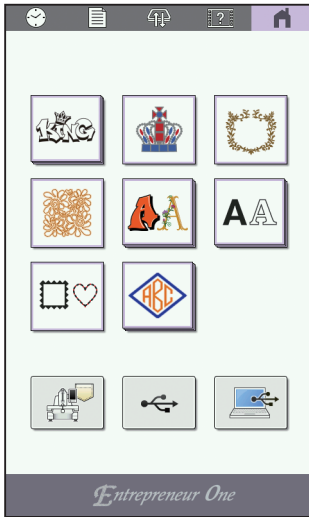





Return



001	A	002	B	003	C	004	D	005	E
006	F	007	G	008	H	009	I	010	J
011	K	012	L	013	M	014	N	015	O

016	P	017	Q	018	R	019	S	020	T
021	U	022	V	023	W	024	X	025	Y
026	Z								



001	0	002	1	003	2	004	3	005	4
006	5	007	6	008	7	009	8	010	9



001	A	002	B	003	C	004	D	005	E
006	F	007	G	008	H	009	I	010	J
011	K	012	L	013	M	014	N	015	O

016	P	017	Q	018	R	019	S	020	T
021	U	022	V	023	W	024	X	025	Y
026	Z								



001	A	002	B	003	C	004	D	005	E
006	F	007	G	008	H	009	I	010	J
011	K	012	L	013	M	014	N	015	O

016	P	017	Q	018	R	019	S	020	T
021	U	022	V	023	W	024	X	025	Y
026	Z	A	B	C	D				

031	E	032	F	033	G	034	H	035	I
036	J	037	K	038	L	039	M	040	N
041	O	042	P	043	Q	044	R	045	S

046	T	047	U	048	V	049	W	050	X
051	Y	052	Z						
056									

061		062		063		064			



001	A	002	B	003	C	004	D	005	E
006	F	007	G	008	H	009	I	010	J
011	K	012	L	013	M	014	N	015	O

016	P	017	Q	018	R	019	S	020	T
021	U	022	V	023	W	024	X	025	Y
026	Z								



001	A	002	B	003	C	004	D	005	E
006	F	007	G	008	H	009	I	010	J
011	K	012	L	013	M	014	N	015	O

016	P	017	Q	018	R	019	S	020	T
021	U	022	V	023	W	024	X	025	Y
026	Z								

AB

001	A	B	C	D	E
006	F	G	H	I	J
011	K	L	M	N	O

016	P	Q	R	S	T
021	U	V	W	X	Y
026	Z	0	1	2	3

031	4	5	6	7	8
036	9				

AA

001	A	B	Γ	Δ	E
006	Z	Θ	Η	Ι	K
011	Λ	M	N	Ξ	O

016	Π	P	Σ	T	Υ
021	Φ	X	Ψ	Ω	

AA

00	<i>ABC</i>				
01	ABC	ABC	ABC		
04	ABC	ABC	ABC		
07	ABC	ABC	ABC		
10	ABC	ABC	ABC		
13	ABC	ABC	ABC		

16	ABC	ABC	ABC
19	ABC	ABC	ABC
22	ABC	ABC	ABC
25	ABCD	ABCD	ABCD
28	ABCD	ABCD	ABCD
30	ABV	ABV	

T01	ABC
-----	-----

*ABC*

ABC	abc	0-9,.	&?!	ÄÄä	ÑÑñ		
A	B	C	D	E	F	G	H
I	J	K	L	M	N	O	P
Q	R	S	T	U	V	W	X
Y	Z						

ABC	abc	0-9,.	&?!	ÄÄä	ÑÑñ		
a	b	c	d	e	f	g	h
i	j	k	l	m	n	o	p
q	r	s	t	u	v	w	x
y	z						

ABC	abc	0-9,.	&?!	ÄÄä	ÑÑñ		
0	1	2	3	4	5	6	7
8	9	#	%	\$	£	€	¥
-	+	x	÷	=	*	.	,

ABC	abc	0-9,.	&?!	ÄÄä	ÑÑñ		
g	p	/	@	<	>	/	/
/	/	/	\	~	.	.	©
@	TM	"	"	"	'	'	'

ABC	abc	0-9,.	&?!	ÄÄä	ÑÑñ		
A	A	A	A	à	á	â	ã
ä	å	æ	ç	ç	Đ	È	É
Ê	Ë	ë	é	ë	í	ï	

ABC	abc	0-9,.	&?!	ÄÄä	ÑÑñ		
N	N	n	Ö	Ö	ø	Ó	œ
ò	ó	ô	õ	ø	õ	œ	í
í	Û	Ü	ù	ú	ü	z	

ABC

ABC	abc	0-9,.	&?!	ÄÄä	ÑÑñ		
A	B	C	D	E	F	G	H
I	J	K	L	M	N	O	P
Q	R	S	T	U	V	W	X
Y	Z						

ABC	abc	0-9,.	&?!	ÄÄä	ÑÑñ		
a	b	c	d	e	f	g	h
i	j	k	l	m	n	o	p
q	r	s	t	u	v	w	x
y	z						

ABC	abc	0-9,.	&?!	ÄÄä	ÑÑñ		
0	1	2	3	4	5	6	7
8	9	#	%	\$	£	€	¥
-	+	x	÷	=	*	.	,

ABC	abc	0-9,.	&?!	ÄÄä	ÑÑñ		
&	?	!	@	<	>	(	)
[	]	/	\	~	:	:	©
®	TM	"	"	"	'	'	'

ABC	abc	0-9,.	&?!	ÄÄä	ÑÑñ		
Â	Ã	Ä	Æ	à	á	â	ã
ä	å	æ	Ç	ç	Đ	È	É
Ê	Ë	ë	é	ë	í	ï	
ì	ì	í	ï	ì			

ABC	abc	0-9,.	&?!	ÄÄä	ÑÑñ		
Ñ	Ñ	ñ	Ô	Õ	ø	Ó	œ
ò	ó	ô	õ	ø	õ	œ	í
í	Û	Ü	ù	ú	ü	z	
þ	þ	þ					

Summary of Embroidery Patterns  
 Sommaire des motifs de broderie  
 Riepilogo dei ricami  
 Resumo dos padrões de bordado

Übersicht der Stickmuster  
 Overzicht van borduurpatronen  
 Resumen de diseños de bordado

02  
 ABC

ABC	abc	0-9..	&?!	ÁÁá	ÑÑñ			
A	B	C	D	E	F	G	H	Delete
I	J	K	L	M	N	O	P	↩
Q	R	S	T	U	V	W	X	
Y	Z						⌵	

ABC	abc	0-9..	&?!	ÁÁá	ÑÑñ			
a	b	c	d	e	f	g	h	Delete
i	j	k	l	m	n	o	p	↩
q	r	s	t	u	v	w	x	
y	z						⌵	

ABC	abc	0-9..	&?!	ÁÁá	ÑÑñ			
0	1	2	3	4	5	6	7	Delete
8	9	#	%	\$	£	€	¥	↩
-	+	x	÷	=	*	.	,	
								⌵

ABC	abc	0-9..	&?!	ÁÁá	ÑÑñ			
&	?	!	@	<	>	(	)	Delete
[	]	/	\	~	:	:	©	↩
®	™	“	”	”	’	’	’	
								⌵

ABC	abc	0-9..	&?!	ÁÁá	ÑÑñ			
Á	Ă	Ȃ	Æ	à	á	â	ã	Delete
ä	å	æ	Ç	ç	Ð	È	É	↩
Ê	Ë	è	é	ê	ë	í	ï	
ì	î	ï	ï	ï	ï			⌵

ABC	abc	0-9..	&?!	ÁÁá	ÑÑñ			
Ñ	Ń	ñ	Ó	Ö	Ø	Ó	Œ	Delete
ò	ó	ô	ö	ø	ó	œ	ř	↩
ť	Ů	Ú	ù	ú	û	ü	ž	
Ɔ	Ɔ	Ɔ						⌵

03  
 ABC

ABC	abc	0-9..	&?!	ÁÁá	ÑÑñ			
A	B	C	D	E	F	G	H	Delete
I	J	K	L	M	N	O	P	↩
Q	R	S	T	U	V	W	X	
Y	Z						⌵	

ABC	abc	0-9..	&?!	ÁÁá	ÑÑñ			
a	b	c	d	e	f	g	h	Delete
i	j	k	l	m	n	o	p	↩
q	r	s	t	u	v	w	x	
y	z						⌵	

ABC	abc	0-9..	&?!	ÁÁá	ÑÑñ			
0	1	2	3	4	5	6	7	Delete
8	9	#	%	\$	£	€	¥	↩
-	+	x	÷	=	*	.	,	
								⌵

ABC	abc	0-9..	&?!	ÁÁá	ÑÑñ			
&	?	!	@	<	>	(	)	Delete
[	]	/	\	~	:	:	©	↩
®	™	“	”	”	’	’	’	
								⌵

ABC	abc	0-9..	&?!	ÁÁá	ÑÑñ			
Ă	Ȃ	Ȃ	Æ	à	á	â	ã	Delete
ä	å	æ	Ç	ç	Ð	È	É	↩
Ê	Ë	è	é	ê	ë	Ĝ	Ĝ	
í	ï	ï	ï	ï	ï	ï	ï	⌵

ABC	abc	0-9..	&?!	ÁÁá	ÑÑñ			
Ñ	Ń	ñ	Ó	Ö	Ø	Ó	Œ	Delete
ò	ó	ô	ö	ø	ó	œ	ř	↩
š	š	ť	Ů	Ú	ù	ú	û	
û	ž	Ɔ	Ɔ	Ɔ				⌵

04  
 ABC

ABC	abc	0-9..	&?!	ÁÁá	ĚĚě	ňňŃ	ŤŤť	
A	B	C	D	E	F	G	H	Delete
I	J	K	L	M	N	O	P	↩
Q	R	S	T	U	V	W	X	
Y	Z						⌵	

ABC	abc	0-9..	&?!	ÁÁá	ĚĚě	ňňŃ	ŤŤť	
a	b	c	d	e	f	g	h	Delete
i	j	k	l	m	n	o	p	↩
q	r	s	t	u	v	w	x	
y	z						⌵	

ABC	abc	0-9..	&?!	ÁÁá	ĚĚě	ňňŃ	ŤŤť	
0	1	2	3	4	5	6	7	Delete
8	9	#	%	\$	£	€	¥	↩
-	+	x	÷	=	*	.	,	
								⌵

ABC	abc	0-9..	&?!	ÁÁá	ĚĚě	ňňŃ	ŤŤť	
&	?	!	@	<	>	(	)	Delete
[	]	/	\	~	:	:	©	↩
®	™	“	”	”	’	’	’	
								⌵

ABC	abc	0-9..	&?!	ÁÁá	ĚĚě	ňňŃ	ŤŤť		
À	Á	Ȃ	Ȃ	Ȃ	Ȃ	Ȃ	Æ	Ă	Delete
Ą	à	á	â	ã	ä	å	æ	↩	
ă	ą	Ç	Ć	Ĉ	ç	é	ĉ		
Đ	Đ	đ						⌵	

ABC	abc	0-9..	&?!	ÁÁá	ĚĚě	ňňŃ	ŤŤť	
È	É	Ê	Ë	Ě	È	è	é	Delete
ê	ë	ę	ě	ě	Ĝ	ĝ	ì	↩
í	ï	ï	ï	ï	ï	ï	ï	
ï	ï	Ł	ł	ł	Ń	Ń	Ń	⌵

ABC	abc	0-9..	&?!	ÁÁá	ĚĚě	ňňŃ	ŤŤť	
ň	ň	ň	Ń	Ń	Ń	Ń	Ń	Delete
Ø	Ŏ	Œ	ò	ó	ô	ö	ø	↩
ø	ó	œ	Ř	Ř	ř	ř	š	
š	š	š	š	š	š	š	š	⌵

ABC	abc	0-9..	&?!	ÁÁá	ĚĚě	ňňŃ	ŤŤť	
Ť	Ť	Ť	ť	ť	ť	Ů	Ú	Delete
Ú	Ů	Ů	ù	ú	ú	ú	ú	↩
Ý	ý	Ž	Ž	ž	ž	ž	ž	
Ɔ	Ɔ	Ɔ						⌵

ABC	abc	0-9..	&?!	ÁÁá	ĚĚě	ňňŃ	ŤŤť	
0	1	2	3	4	5	6	7	Delete
8	9	#	%	\$	£	€	¥	↩
-	+	x	÷	=	*	.	,	
								⌵

05  
 ABC

ABC	abc	0-9..	&?!	ÁÁá	ĚĚě	ňňŃ	ŤŤť	
A	B	C	D	E	F	G	H	Delete
I	J	K	L	M	N	O	P	↩
Q	R	S	T	U	V	W	X	
Y	Z						⌵	

ABC	abc	0-9..	&?!	ÁÁá	ĚĚě	ňňŃ	ŤŤť	
a	b	c	d	e	f	g	h	Delete
i	j	k	l	m	n	o	p	↩
q	r	s	t	u	v	w	x	
y	z						⌵	

ABC	abc	0-9..	&?!	ÁÁá	ĚĚě	ňňŃ	ŤŤť	
0	1	2	3	4	5	6	7	Delete
8	9	#	%	\$	£	€	¥	↩
-	+	x	÷	=	*	.	,	
								⌵

ABC	abc	0-9..	&?! [ ]	ÄÄä	ÉÉé	ññÖ	ŤŤť
&	?	!	@	<	>	[	]
[	]	/	\	~	:	:	©
®	™	“	”	”	’	’	’

ABC	abc	0-9..	&?! [ ]	ÄÄä	ÉÉé	ññÖ	ŤŤť
À	Á	Â	Ã	Ä	Å	Æ	Ǽ
À	á	â	ã	ä	å	æ	ǽ
Ǽ	ǽ	Ç	Ć	Č	ç	ć	č
Đ	Ǿ	đ					

ABC	abc	0-9..	&?! [ ]	ÄÄä	ÉÉé	ññÖ	ŤŤť
È	É	Ê	Ë	Ě	Ě	è	é
ê	ë	ë	ě	ě	Ĝ	ğ	İ
İ	ı	İ	ı	ı	ı	ı	ı
İ	ı	Ł	ł	ł	Ń	ń	Ń

ABC	abc	0-9..	&?! [ ]	ÄÄä	ÉÉé	ññÖ	ŤŤť
ň	ń	ň	ò	ó	ô	õ	ö
ø	ő	œ	ř	ř	ř	ř	š
š	š	š	š	š	š	š	š

ABC	abc	0-9..	&?! [ ]	ÄÄä	ÉÉé	ññÖ	ŤŤť
Ť	Ť	Ť	Ť	Ť	Ť	Ť	Ť
Ů	Ů	Ů	Ů	Ů	Ů	Ů	Ů
Ÿ	Ÿ	Ž	Ž	Ž	ž	ž	ž
ƀ	Ɓ	Ƃ					

ABC	abc	0-9..	&?! [ ]	ÄÄä	ÉÉé	ññÖ	ŤŤť
0	1	2	3	4	5	6	7
8	9	#	%	\$	£	€	¥
-	+	x	÷	=	*	.	,

06 ABC

ABC	abc	0-9..	&?! [ ]	ÄÄä	ÉÉé	ññÖ	ŤŤť
A	B	C	D	E	F	G	H
I	J	K	L	M	N	O	P
Q	R	S	T	U	V	W	X
Y	Z						

ABC	abc	0-9..	&?! [ ]	ÄÄä	ÉÉé	ññÖ	ŤŤť
a	b	c	d	e	f	g	h
i	j	k	l	m	n	o	p
q	r	s	t	u	v	w	x
y	z						

ABC	abc	0-9..	&?! [ ]	ÄÄä	ÉÉé	ññÖ	ŤŤť
0	1	2	3	4	5	6	7
8	9	#	%	\$	£	€	¥
-	+	x	÷	=	*	.	,

ABC	abc	0-9..	&?! [ ]	ÄÄä	ÉÉé	ññÖ	ŤŤť
É	É	É	É	É	É	É	É
É	É	É	É	É	É	É	É
É	É	É	É	É	É	É	É

ABC	abc	0-9..	&?! [ ]	ÄÄä	ÉÉé	ññÖ	ŤŤť
Á	Ā	Ă	Ą	Ȧ	Ȧ	Ȧ	Ȧ
ā	ā	ă	ą	Ȧ	Ȧ	Ȧ	Ȧ
Ȧ	Ȧ	Ȧ	Ȧ	Ȧ	Ȧ	Ȧ	Ȧ

ABC	abc	0-9..	&?! [ ]	ÄÄä	ÉÉé	ññÖ	ŤŤť
Ń	Ń	Ń	Ń	Ń	Ń	Ń	Ń
Ń	Ń	Ń	Ń	Ń	Ń	Ń	Ń
Ń	Ń	Ń	Ń	Ń	Ń	Ń	Ń

07 ABC

ABC	abc	0-9..	&?! [ ]	ÄÄä	ÉÉé	ññÖ	ŤŤť
Ŕ	Ŕ	Ŕ	Ŕ	Ŕ	Ŕ	Ŕ	Ŕ
Ŕ	Ŕ	Ŕ	Ŕ	Ŕ	Ŕ	Ŕ	Ŕ
Ŕ	Ŕ	Ŕ	Ŕ	Ŕ	Ŕ	Ŕ	Ŕ

ABC	abc	0-9..	&?! [ ]	ÄÄä	ÉÉé	ññÖ	ŤŤť
a	b	c	d	e	f	g	h
i	j	k	l	m	n	o	p
q	r	s	t	u	v	w	x
y	z						

ABC	abc	0-9..	&?! [ ]	ÄÄä	ÉÉé	ññÖ	ŤŤť
0	1	2	3	4	5	6	7
8	9	#	%	\$	£	€	¥
-	+	x	÷	=	*	.	,

ABC	abc	0-9..	&?! [ ]	ÄÄä	ÉÉé	ññÖ	ŤŤť
Š	Š	Š	Š	Š	Š	Š	Š
Š	Š	Š	Š	Š	Š	Š	Š
Š	Š	Š	Š	Š	Š	Š	Š

ABC	abc	0-9..	&?! [ ]	ÄÄä	ÉÉé	ññÖ	ŤŤť
Š	Š	Š	Š	Š	Š	Š	Š
Š	Š	Š	Š	Š	Š	Š	Š
Š	Š	Š	Š	Š	Š	Š	Š

ABC	abc	0-9..	&?! [ ]	ÄÄä	ÉÉé	ññÖ	ŤŤť
Š	Š	Š	Š	Š	Š	Š	Š
Š	Š	Š	Š	Š	Š	Š	Š
Š	Š	Š	Š	Š	Š	Š	Š

ABC	abc	0-9..	&?! [ ]	ÄÄä	ÉÉé	ññÖ	ŤŤť
Š	Š	Š	Š	Š	Š	Š	Š
Š	Š	Š	Š	Š	Š	Š	Š
Š	Š	Š	Š	Š	Š	Š	Š

ABC	abc	0-9..	&?! [ ]	ÄÄä	ÉÉé	ññÖ	ŤŤť
Ť	Ť	Ť	Ť	Ť	Ť	Ť	Ť
Ť	Ť	Ť	Ť	Ť	Ť	Ť	Ť
Ť	Ť	Ť	Ť	Ť	Ť	Ť	Ť

ABC	abc	0-9..	&?! [ ]	ÄÄä	ÉÉé	ññÖ	ŤŤť
Ť	Ť	Ť	Ť	Ť	Ť	Ť	Ť
Ť	Ť	Ť	Ť	Ť	Ť	Ť	Ť
Ť	Ť	Ť	Ť	Ť	Ť	Ť	Ť

08 ABC

ABC	abc	0-9..	&?! [ ]	ÄÄä	ÉÉé	ññÖ	ŤŤť
A	B	C	D	E	F	G	H
I	J	K	L	M	N	O	P
Q	R	S	T	U	V	W	X
Y	Z						

ABC	abc	0-9..	&?! [ ]	ÄÄä	ÉÉé	ññÖ	ŤŤť
a	b	c	d	e	f	g	h
i	j	k	l	m	n	o	p
q	r	s	t	u	v	w	x
y	z						

ABC	abc	0-9..	&?! [ ]	ÄÄä	ÉÉé	ññÖ	ŤŤť
0	1	2	3	4	5	6	7
8	9	#	%	\$	£	-	+
=	*	.	,				



Summary of Embroidery Patterns  
 Sommaire des motifs de broderie  
 Riepilogo dei ricami  
 Resumo dos padrões de bordado

Übersicht der Stickmuster  
 Overzicht van borduurpatronen  
 Resumen de diseños de bordado

09

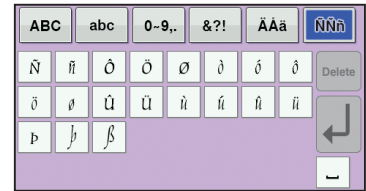
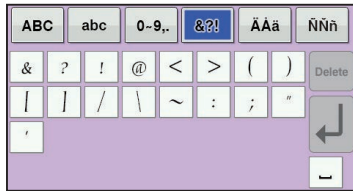

10

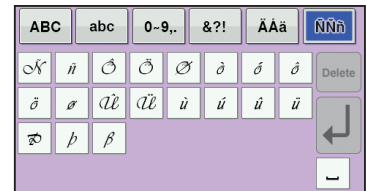
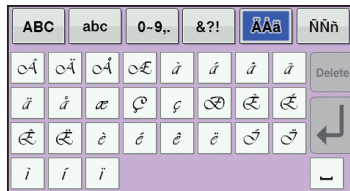
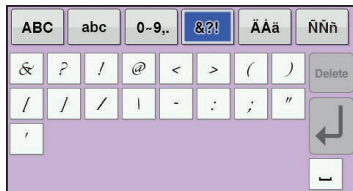
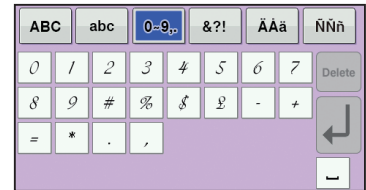
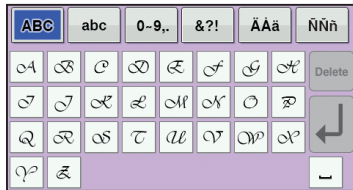

11

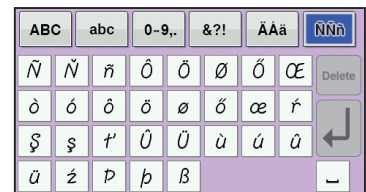
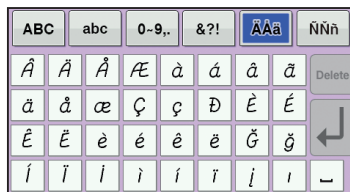
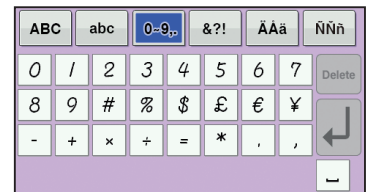
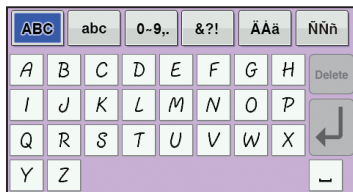
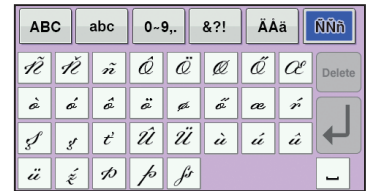
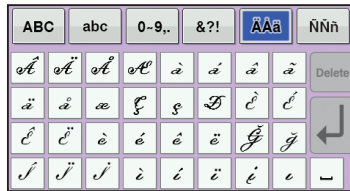
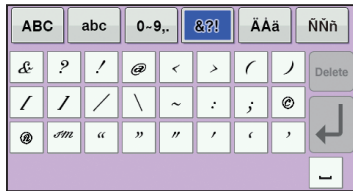
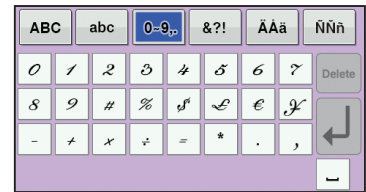
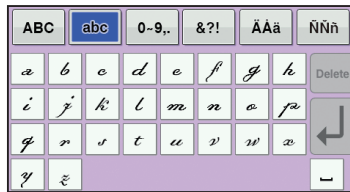
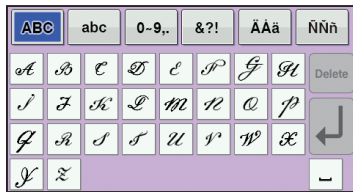

12

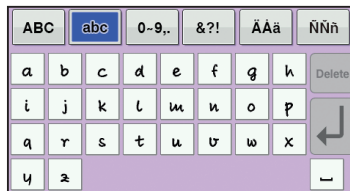
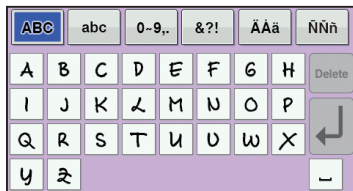

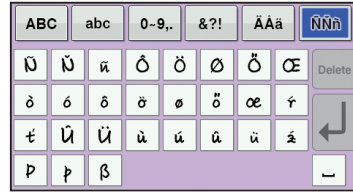
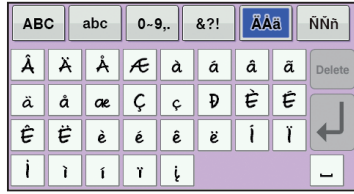

13 ABC

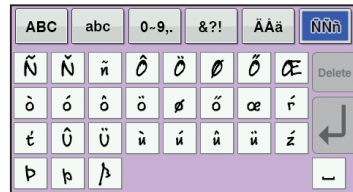
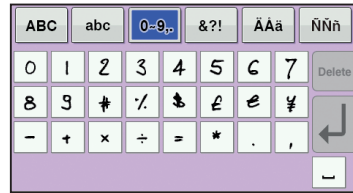
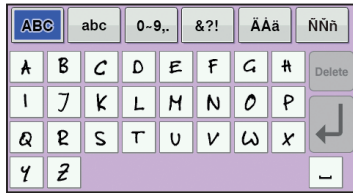

14 ABC

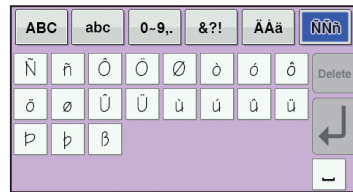
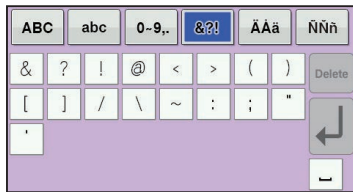
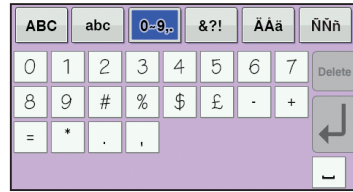
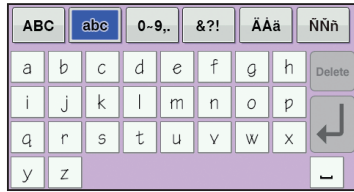
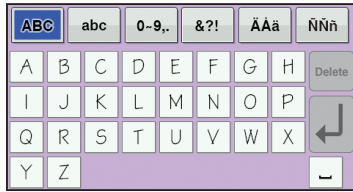

15 ABC

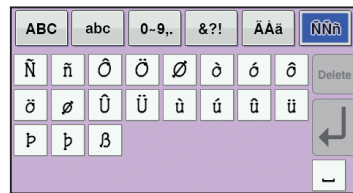
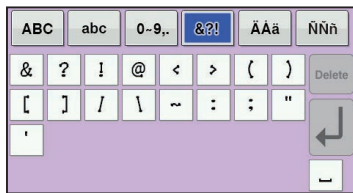
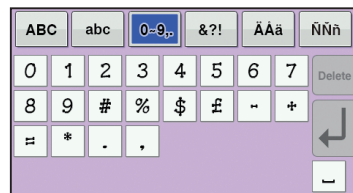
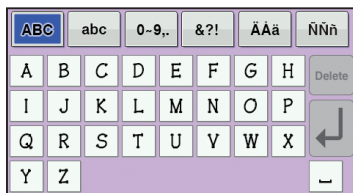

16 ABC

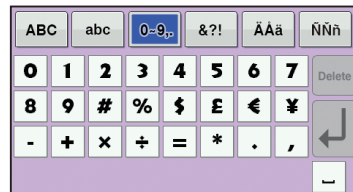
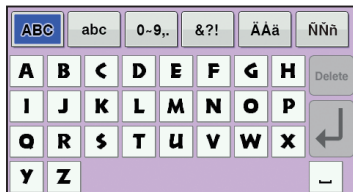

Summary of Embroidery Patterns  
 Sommaire des motifs de broderie  
 Riepilogo dei ricami  
 Resumo dos padrões de bordado

Übersicht der Stickmuster  
 Overzicht van borduurpatronen  
 Resumen de diseños de bordado

17  
**ABC**

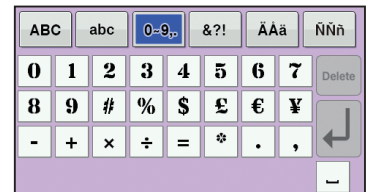
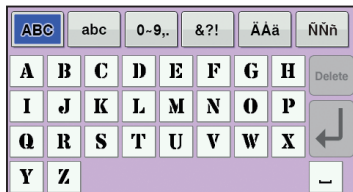
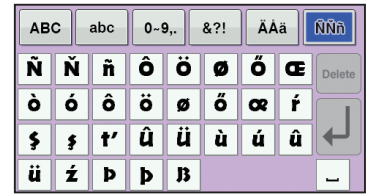
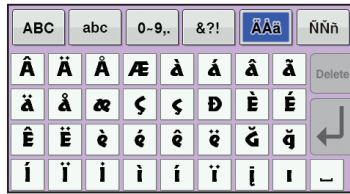
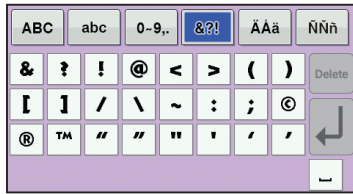

18  
**ABC**

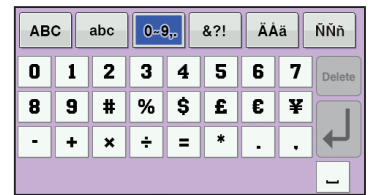
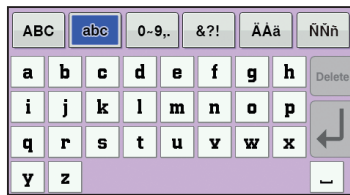
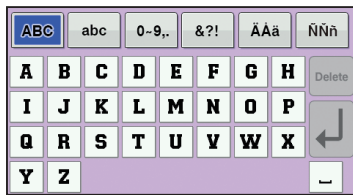
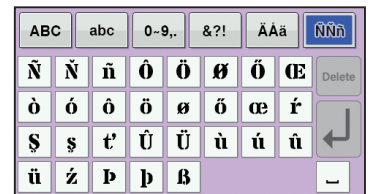
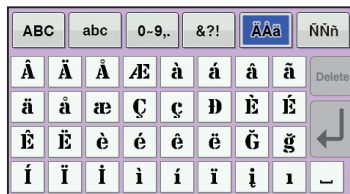

19  
**ABC**

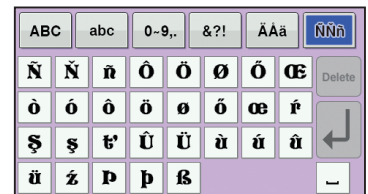
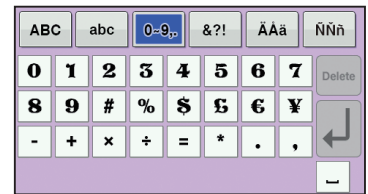
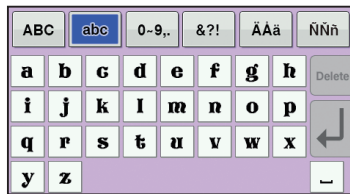
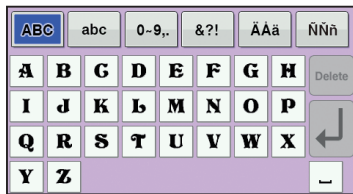



20 ABC

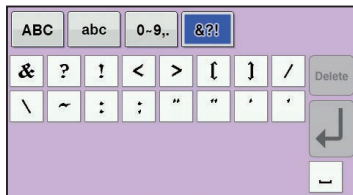
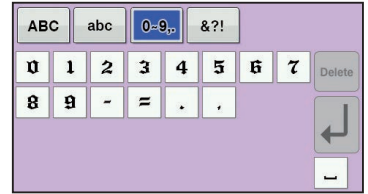
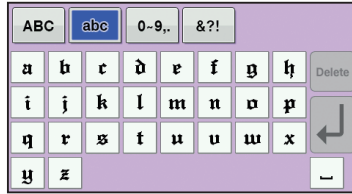
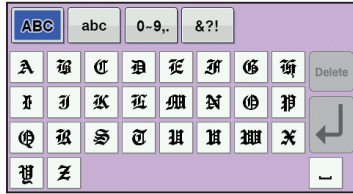

21 ABC

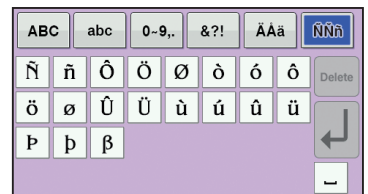
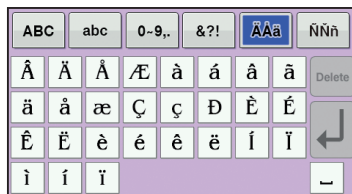
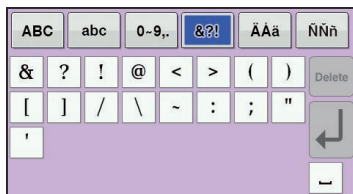
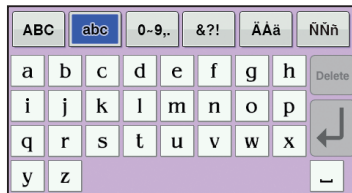
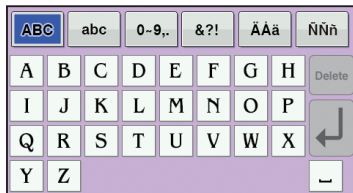

22 ABC

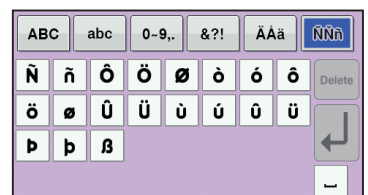
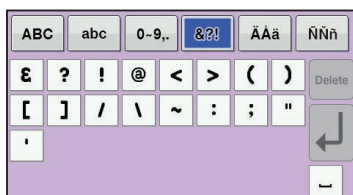
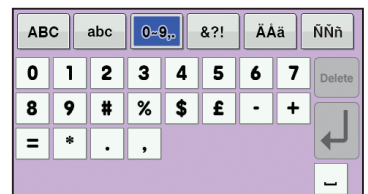
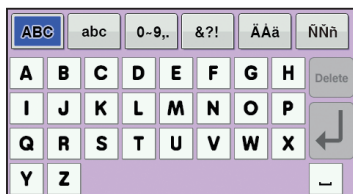

23 ABC

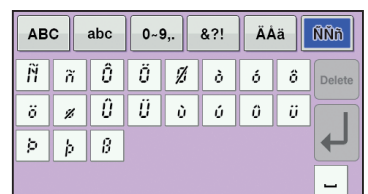
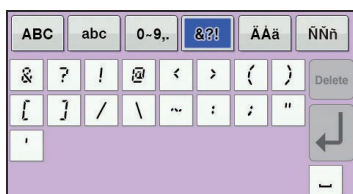

Summary of Embroidery Patterns  
Sommaire des motifs de broderie  
Riepilogo dei ricami  
Resumo dos padrões de bordado

Übersicht der Stickmuster  
Overzicht van borduurpatronen  
Resumen de diseños de bordado

24  
ABC

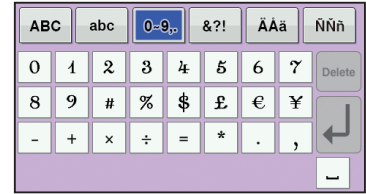

25  
ABCD

Small font  
Kleine Schriftart  
Petite police  
Klein lettertype  
Font piccolo  
Tipo de letra pequena  
Fonte pequena

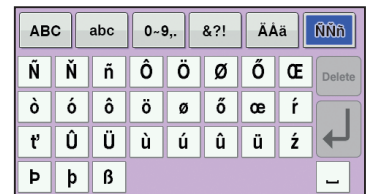
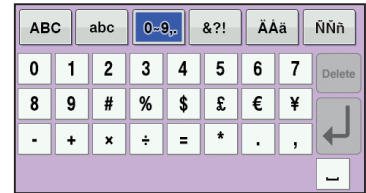
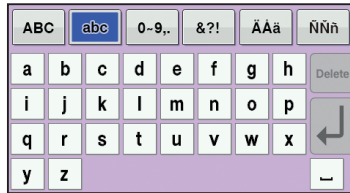
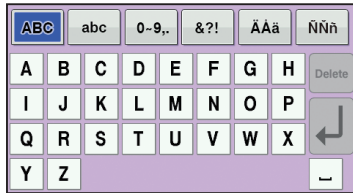

26  
ABCD

Small font  
Kleine Schriftart  
Petite police  
Klein lettertype  
Font piccolo  
Tipo de letra pequena  
Fonte pequena

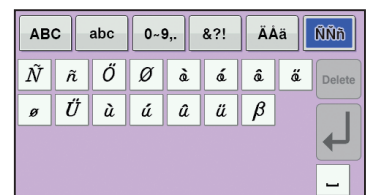
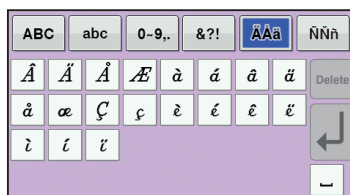
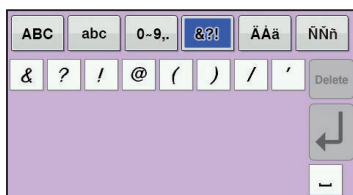
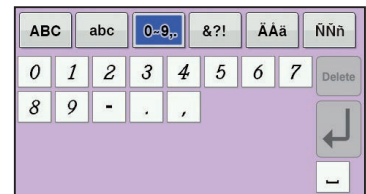
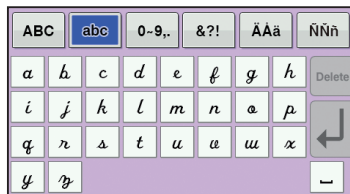
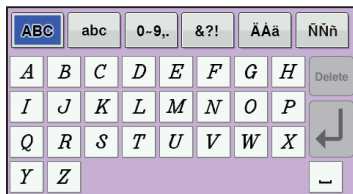

27  
ABCD

Small font  
Kleine Schriftart  
Petite police  
Klein lettertype  
Font piccolo  
Tipo de letra pequena  
Fonte pequena

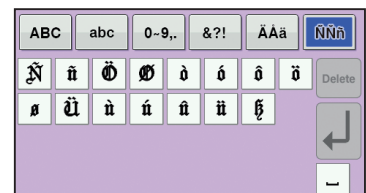
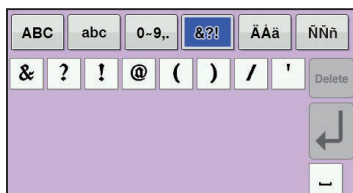
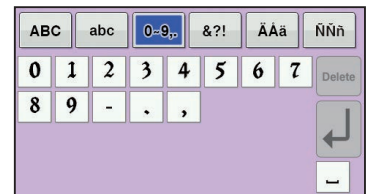
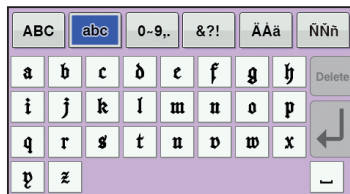
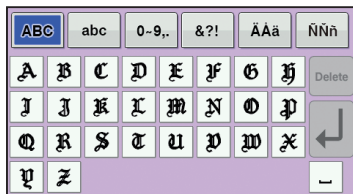

28

Small font  
 Kleine Schriftart  
 Petite police  
 Klein lettertype  
 Font piccolo  
 Tipo de letra pequena  
 Fonte pequena

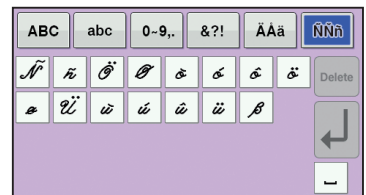
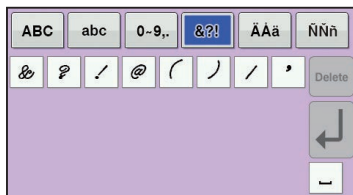
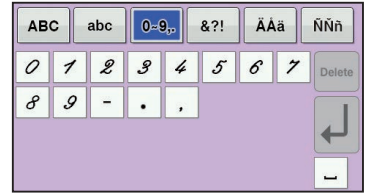
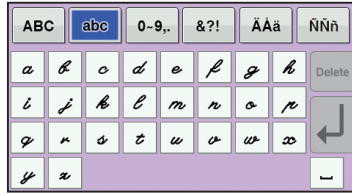
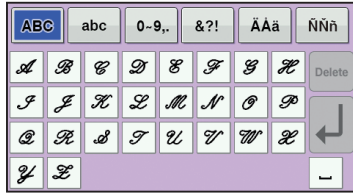

29

Small font  
 Kleine Schriftart  
 Petite police  
 Klein lettertype  
 Font piccolo  
 Tipo de letra pequena  
 Fonte pequena

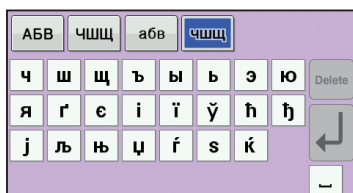
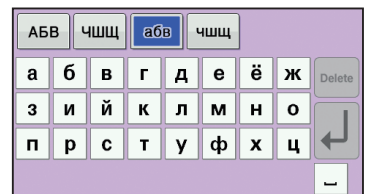
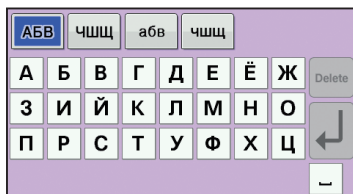
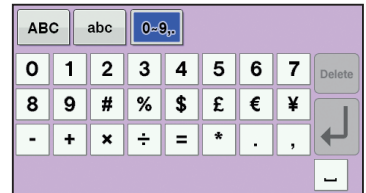
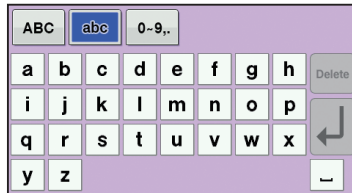
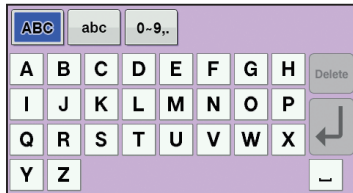

31

Small font  
 Kleine Schriftart  
 Petite police  
 Klein lettertype  
 Font piccolo  
 Tipo de letra pequena  
 Fonte pequena



T01

Small font  
 Kleine Schriftart  
 Petite police  
 Klein lettertype  
 Font piccolo  
 Tipo de letra pequena  
 Fonte pequena

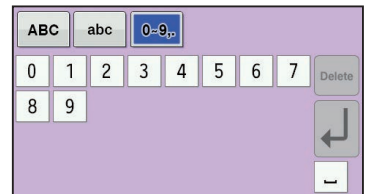
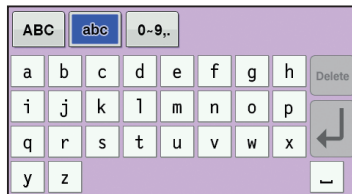
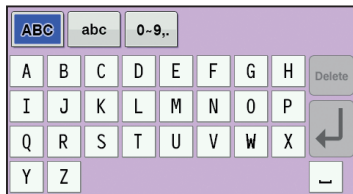

Summary of Embroidery Patterns  
 Sommaire des motifs de broderie  
 Riepilogo dei ricami  
 Resumo dos padrões de bordado

Übersicht der Stickmuster  
 Overzicht van borduurpatronen  
 Resumen de diseños de bordado





Summary of Embroidery Patterns  
 Sommaire des motifs de broderie  
 Riepilogo dei ricami  
 Resumo dos padrões de bordado

Übersicht der Stickmuster  
 Overzicht van borduurpatronen  
 Resumen de diseños de bordado

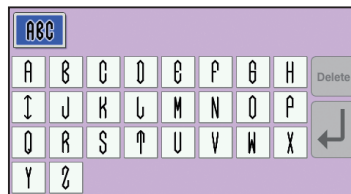
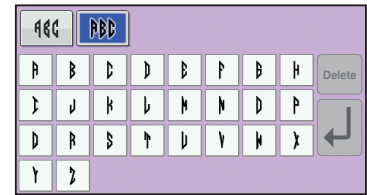
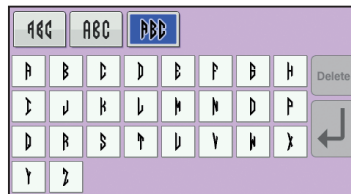
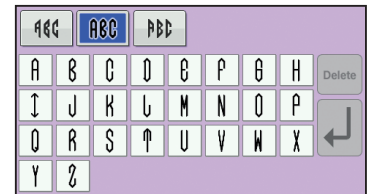
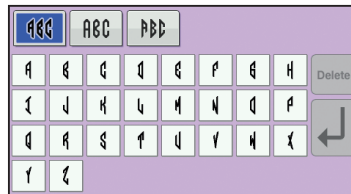
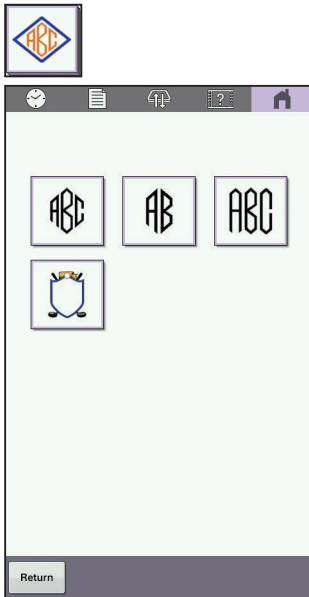
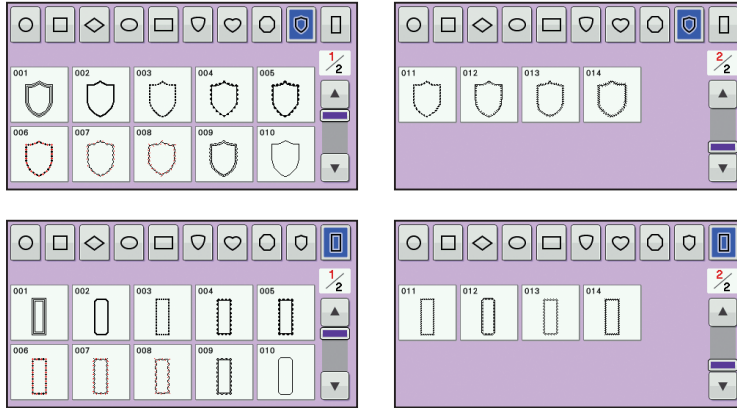

# Embroidery Patterns Color Change Table

## Tableau de changement de couleur des motifs de broderie

### Tabella dei cambi colore dei ricami

### Tabela de alteração de cor do padrão de bordado

# Stickdesign-Farbtabelle

## Kleurenvolgorde voor de borduurontwerpen

### Tabla de cambios de color para diseños de bordado

Embroidery time and size of each design in this guide may differ from the information on the machine display. Please use for reference purpose only. The color numbers in this guide are for the Embroidery thread brand unless otherwise noted.

(●) Patterns marked with ● have been rotated. Check your design placement prior to embroidering.

La durée de broderie et la taille de chaque motif présenté dans ce guide peuvent différer des informations affichées à l'écran de la machine. Merci de les utiliser à titre de référence uniquement.

Les numéros des couleurs dans ce guide correspondent à la marque de fils à broder, sauf indication contraire.

(●) Les motifs signalés par ● ont été pivotés. Vérifiez l'emplacement de votre motif avant de commencer à broder.

Il tempo di ricamo e le dimensioni di ciascun ricamo in questa guida possono differire dalle informazioni sul display della macchina. Si prega di utilizzare solo come riferimento.

Salvo diversa indicazione, i numeri dei colori riportati in questa guida corrispondono alla marca del filo per ricamo.

(●) I ricami contrassegnati dal simbolo ● appaiono ruotati. Prima di procedere a ricamare, verificare la posizione del ricamo.

O tempo e o tamanho do bordado de cada desenho neste guia podem ser diferentes das informações exibidas na tela da máquina. Use apenas para fins de referência.

Os números de cores neste guia são para marcas de linha de bordar, a menos que indicados de outra forma.

(●) Os padrões marcados com ● foram invertidos. Verifique o posicionamento do seu desenho antes de bordar.

Die Stickzeit und die Größe jedes Designs in dieser Anleitung können von den Informationen im Display abweichen. Bitte verwenden Sie die Angaben nur als Referenz.

Die Farbnummern in dieser Anleitung beziehen sich auf die Stickgarnmarke, sofern nicht anders angegeben.

(●) Muster, die mit ● gekennzeichnet sind, wurden gedreht. Überprüfen Sie die Platzierung Ihres Designs, bevor Sie mit Stickern beginnen.

De informatie in deze handleiding over de borduurtijd en de afmeting van het borduurpatroon kan afwijken van de weergave op het beeldscherm van de machine. Gelieve de informatie alleen te gebruiken als richtlijn.

De kleurnummers in deze handleiding verwijzen naar een borduurgarenmerk tenzij anders vermeld.

(●) Patronen die zijn gemarkeerd met ● zijn geroteerd. Controleer de plaats van uw ontwerp voordat u gaat borduren.

El tiempo de bordado y el tamaño de cada diseño en esta guía pueden diferir de la información en la pantalla de la máquina. Por favor, use solo como referencia.

Los números de colores en esta guía se refieren a la marca de hilos de Bordado, a menos que se indique lo contrario.

(●) Los patrones marcado con ● se han girado. Compruebe la colocación del diseño antes de bordar.

### ❖ "Featured" design patterns

### ❖ Motifs « à la une »

### ❖ Ricami "inclusi"

### ❖ Padrões de desenho "em destaque"

### ❖ „Vorgestellte“ Stickdesigns

### ❖ "Specifieke" ontwerp patronen

### ❖ Patrones de diseño "destacados"



**No.1**

Order to embroider  
Stickreihenfolge  
Séquence de broderie  
Borduurvolgorde  
Sequenza dei cambi colore del ricamo  
Orden para el bordador  
Ordem para bordar

**21 min**

1	□ (001)
2	■ (900)
↓ 70.4 mm	
↔ 125.9 mm	

Time required for embroidering  
Stickdauer  
Durée requise pour broder  
Tijd benodigd voor het borduren  
Tempo di ricamo necessario  
Tiempo requerido para el bordado  
Tempo necessário para bordar

Embroidery thread color number  
Stickgarn-Farbnummer  
Numéro de couleur du fil de broderie  
Kleurnummer borduurgaren  
Numero del colore del filo da ricamo  
Número de color del hilo de bordado  
Número da cor da linha de bordar

Embroidery size  
Größe der Stickerei  
Taille de la broderie  
Afmeting borduurmotief  
Dimensioni del ricamo  
Tecla de tamaño  
Tamanho do bordado

**No.2**

Time required for embroidering  
Stickdauer  
Durée requise pour broder  
Tijd benodigd voor het borduren  
Tempo di ricamo necessario  
Tiempo requerido para el bordado  
Tempo necessário para bordar

Embroidery thread color number  
Stickgarn-Farbnummer  
Numéro de couleur du fil de broderie  
Kleurnummer borduurgaren  
Numero del colore del filo da ricamo  
Número de color del hilo de bordado  
Número da cor da linha de bordar

Embroidery size  
Größe der Stickerei  
Taille de la broderie  
Afmeting borduurmotief  
Dimensioni del ricamo  
Tecla de tamaño  
Tamanho do bordado

**17 min**

1	□ (208)
2	■ (900)
↓ 107.8 mm	
↔ 87.0 mm	



● No.3

95 min	
1	(399)
2	(001)
3	(214)
4	(900)
5	(214)
↓ 193.4 mm	
↔ 238.5 mm	



No.6

7 min	
1	(328)
2	(330)
↓ 85.5 mm	
↔ 94.8 mm	



No.7

14 min	
1	(900)
↓ 84.8 mm	
↔ 131.1 mm	



● No.4

108 min	
1	(704)
2	(005)
3	(900)
4	(704)
5	(005)
6	(900)
7	(005)
8	(704)
9	(005)
10	(704)
11	(005)
12	(900)
13	(005)
↓ 195.0 mm	
↔ 264.5 mm	



No.8

31 min	
1	(085)
↓ 152.0 mm	
↔ 185.1 mm	

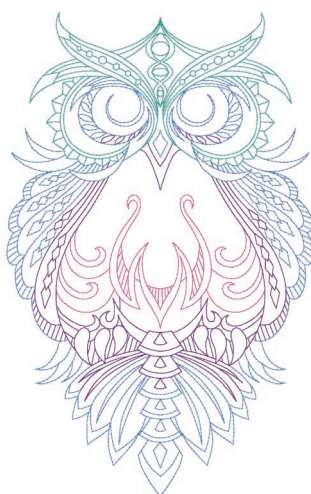

● No.5

15 min	
1	(613)
2	(086)
3	(070)
4	(613)
5	(070)
6	(534)
↓ 162.0 mm	
↔ 255.3 mm	



● No.9

113 min			
1	(307)	17	(507)
2	(900)	18	(085)
3	(307)	19	(807)
4	(807)	20	(085)
5	(513)	21	(807)
6	(507)	22	(085)
7	(513)	23	(307)
8	(507)	24	(807)
9	(513)	25	(513)
10	(507)	26	(507)
11	(807)	27	(807)
12	(513)	28	(507)
13	(507)	29	(513)
14	(513)	30	(085)
15	(507)	31	(807)
16	(513)	32	(085)
↓ 183.2 mm ↔ 277.5 mm			





**No.1** **7 min**

**BoHo**

1	(800)
2	(348)
↓	50.0 mm
↔	91.9 mm

**No.2** **10 min**

**GROOVY**

1	(513)
2	(085)
3	(348)
4	(620)
↓	43.3 mm
↔	148.2 mm

**No.3** **15 min**

**GOOD VIBES**

1	(534)
2	(030)
3	(208)
↓	98.8 mm
↔	109.7 mm

**No.4** **30 min**

1	(542)
2	(085)
3	(812)
4	(620)
5	(030)
↓	194.6 mm
↔	276.9 mm

**No.5** **6 min**

1	(542)
2	(812)
3	(030)
↓	147.2 mm
↔	44.2 mm

- ✂ Embroidery patterns
- ✂ Motifs de broderie
- ✂ Ricami
- ✂ Padrões de bordado

- ✂ Stickdesigns
- ✂ Borduurontwerpen
- ✂ Diseños de bordado



**No.1** **4 min**

1	(107)
2	(007)
3	(005)
4	(007)
5	(107)
↓	40.1 mm
↔	41.3 mm

**No.3** **1 min**

1	(612)
2	(515)
3	(534)
4	(620)
↓	28.2 mm
↔	27.4 mm

**No.5** **2 min**

1	(509)
2	(515)
↓	26.3 mm
↔	26.6 mm

**No.2** **2 min**

1	(812)
2	(205)
↓	32.1 mm
↔	30.2 mm

**No.4** **1 min**



1	(079)
2	(001)
3	(058)
↓	19.1 mm
↔	29.3 mm

**No.6** **1 min**

1	(399)
2	(348)
↓	31.2 mm
↔	21.1 mm

**No.7**

**1 min**

1  (328)  
 2  (214)  
 ↓ 37.6 mm  
 ⇔ 15.3 mm



**No.12**







**7 min**

1  (005)  
 ↓ 68.2 mm  
 ⇔ 53.8 mm



**No.17**

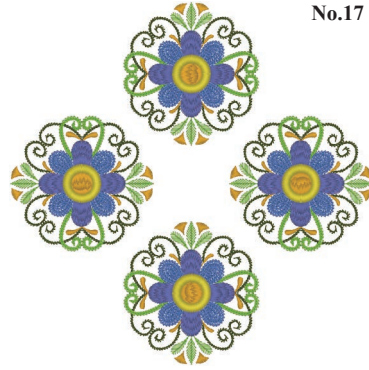

**39 min**

1  (517)  
 2  (214)  
 3  (513)  
 4  (070)  
 5  (607)  
 6  (214)  
 7  (206)  
 ↓ 192.5 mm  
 ⇔ 192.5 mm



**No.8**

**1 min**

1  (001)  
 2  (509)  
 3  (058)  
 ↓ 29.9 mm  
 ⇔ 23.8 mm



**No.13**



**2 min**

1  (214)  
 ↓ 39.3 mm  
 ⇔ 38.4 mm



**No.9**

**1 min**

1  (900)  
 2  (800)  
 3  (900)  
 ↓ 15.0 mm  
 ⇔ 16.1 mm



**No.14**















**6 min**

1  (214)  
 ↓ 68.5 mm  
 ⇔ 69.5 mm



**No.18**









**36 min**

1  (399)  
 2  (517)  
 3  (607)  
 4  (070)  
 5  (804)  
 6  (613)  
 7  (214)  
 8  (399)  
 9  (517)  
 10  (607)  
 11  (070)  
 12  (804)  
 13  (613)  
 14  (214)  
 ↓ 185.9 mm  
 ⇔ 185.9 mm



**No.10**





**2 min**

1  (348)  
 2  (001)  
 3  (517)  
 4  (515)  
 5  (323)  
 6  (058)  
 7  (214)  
 8  (208)  
 ↓ 30.8 mm  
 ⇔ 27.6 mm



**No.15**







**4 min**

1  (348)  
 2  (399)  
 3  (085)  
 4  (124)  
 ↓ 41.4 mm  
 ⇔ 49.3 mm



**No.19**

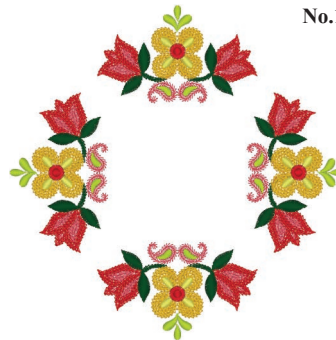

**29 min**

1  (513)  
 2  (085)  
 3  (807)  
 4  (507)  
 5  (209)  
 6  (206)  
 7  (807)  
 ↓ 177.3 mm  
 ⇔ 177.4 mm



**No.11**





**2 min**

1  (001)  
 2  (515)  
 3  (800)  
 4  (214)  
 5  (001)  
 ↓ 31.0 mm  
 ⇔ 30.9 mm



**No.16**

**13 min**

1  (348)  
 2  (124)  
 3  (085)  
 4  (399)  
 ↓ 88.1 mm  
 ⇔ 157.9 mm



**Embroidery Patterns Color Change Table**  
**Tableau de changement de couleur des motifs de broderie**  
**Tabella dei cambi colore dei ricami**  
**Tabela de alteração de cor do padrão de bordado**

**Stickdesign-Farbtabelle**  
**Kleurenvolgorde voor de borduurontwerpen**  
**Tabla de cambios de color para diseños de bordado**

**No.20** **41 min**



1	(613)
2	(001)
3	(086)
4	(542)
5	(613)
6	(001)
7	(086)
8	(542)
9	(613)
10	(001)
11	(086)
12	(542)
13	(613)
14	(001)
15	(086)
16	(542)

↓ 194.0 mm  
 ⇔ 194.0 mm

**No.21** **36 min**

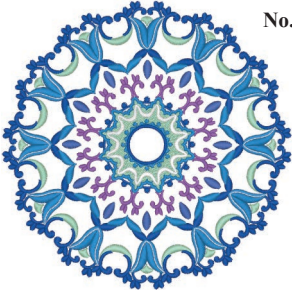

1	(612)	7	(542)
2	(405)	8	(405)
3	(542)	9	(019)
4	(001)	10	(001)
5	(019)	11	(070)
6	(405)		

↓ 153.0 mm ⇔ 153.5 mm

**No.22**



**51 min**

1	(515)	15	(019)	29	(010)	43	(208)	57	(513)
2	(027)	16	(208)	30	(323)	44	(843)	58	(534)
3	(513)	17	(843)	31	(513)	45	(010)	59	(707)
4	(058)	18	(010)	32	(534)	46	(810)	60	(208)
5	(208)	19	(810)	33	(019)	47	(010)	61	(513)
6	(070)	20	(010)	34	(208)	48	(323)	62	(515)
7	(019)	21	(323)	35	(843)	49	(070)	63	(027)
8	(209)	22	(513)	36	(010)	50	(208)	64	(513)
9	(208)	23	(534)	37	(810)	51	(001)	65	(058)
10	(800)	24	(019)	38	(010)	52	(058)	66	(208)
11	(405)	25	(208)	39	(323)	53	(010)	67	(070)
12	(058)	26	(843)	40	(513)	54	(070)	68	(019)
13	(513)	27	(010)	41	(534)	55	(058)		
14	(534)	28	(810)	42	(019)	56	(620)		

↓ 195.8 mm ⇔ 195.8 mm

**No.23** **37 min**

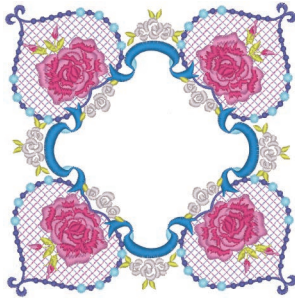

1	(804)
2	(810)
3	(607)
4	(017)
5	(019)
6	(085)
7	(086)
8	(027)
9	(124)

↓ 156.0 mm  
 ⇔ 155.1 mm

**No.24** **23 min**



1	(107)
2	(086)

↓ 148.2 mm  
 ⇔ 195.4 mm

**No.25** **22 min**



1	(405)
2	(420)

↓ 148.2 mm  
 ⇔ 195.4 mm

**No.26** **22 min**



1	(517)
2	(515)

↓ 148.2 mm  
 ⇔ 195.4 mm

**No.27** **22 min**



1	(007)
2	(405)

↓ 148.2 mm  
 ⇔ 195.4 mm



**No.28**



**56 min**

1	(208)	12	(307)
2	(323)	13	(126)
3	(126)	14	(333)
4	(058)	15	(208)
5	(800)	16	(126)
6	(107)	17	(001)
7	(058)	18	(800)
8	(001)	19	(058)
9	(126)	20	(107)
10	(399)	21	(399)
11	(107)	22	(058)

↓ 194.3 mm ↔ 145.2 mm

**No.31**



**10 min**

1	(399)
2	(001)

↓ 85.5 mm  
↔ 56.0 mm

**No.32**



**4 min**

1	(328)
---	-------

↓ 74.1 mm  
↔ 54.1 mm

**No.29**



**42 min**

1	(208)
2	(900)
3	(620)
4	(339)
5	(900)

↓ 182.7 mm  
↔ 194.7 mm

**No.33**



**3 min**

1	(328)
2	(348)

↓ 42.4 mm  
↔ 40.1 mm

**No.30**

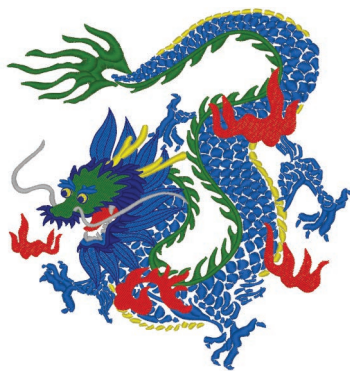

**51 min**

1	(420)
2	(515)
3	(206)
4	(420)
5	(007)
6	(800)
7	(515)
8	(206)
9	(007)
10	(005)
11	(420)
12	(800)

↓ 192.2 mm  
↔ 184.1 mm

**No.34**



**11 min**

1	(209)	6	(339)
2	(206)	7	(323)
3	(209)	8	(001)
4	(900)	9	(843)
5	(206)	10	(900)

↓ 55.2 mm ↔ 118.9 mm

- ❖ Decoration/Hallmark patterns
- ❖ Motifs de décoration/d'emblème
- ❖ Ricami Decorazione/Stemma
- ❖ Desenhos decorativos/molduras e símbolos

- ❖ Dekor-/Ornamentmuster
- ❖ Ornamenten en decoratieve ontwerpen
- ❖ Diseños ornamentales/de marcos decorativos



**No.1** **12 min**

1	■	(707)
2	■	(817)
3	■	(707)

↓ 195.6 mm  
 ⇔ 160.0 mm

**No.7** **1 min**

1	■	(900)
---	---	-------

↓ 18.9 mm  
 ⇔ 62.7 mm

**No.15** **2 min**

1	■	(900)
---	---	-------

↓ 8.1 mm  
 ⇔ 182.8 mm

**No.8** **6 min**

1	■	(900)
---	---	-------

↓ 62.4 mm  
 ⇔ 123.6 mm



**No.2** **4 min**

1	■	(817)
2	■	(707)

↓ 81.8 mm  
 ⇔ 111.8 mm

**No.9** **1 min**

1	■	(900)
---	---	-------

↓ 23.8 mm  
 ⇔ 58.5 mm

**No.16** **19 min**

1	■	(399)
2	■	(804)

↓ 186.8 mm  
 ⇔ 160.1 mm

**No.10** **1 min**

1	■	(900)
---	---	-------

↓ 40.6 mm  
 ⇔ 74.9 mm

**No.3** **3 min**

1	■	(707)
2	■	(817)

↓ 39.4 mm  
 ⇔ 136.7 mm

**No.11** **1 min**

1	■	(900)
---	---	-------

↓ 15.2 mm  
 ⇔ 62.9 mm

**No.17** **12 min**

1	■	(399)
2	■	(804)

↓ 84.6 mm  
 ⇔ 143.0 mm

**No.4** **2 min**

1	■	(900)
---	---	-------

↓ 25.0 mm  
 ⇔ 69.8 mm

**No.12** **3 min**

1	■	(900)
---	---	-------

↓ 37.8 mm  
 ⇔ 125.4 mm



**No.5** **2 min**

1	■	(900)
---	---	-------

↓ 40.5 mm  
 ⇔ 90.3 mm

**No.13** **3 min**

1	■	(900)
---	---	-------

↓ 24.7 mm  
 ⇔ 129.1 mm

**No.18** **10 min**

1	■	(399)
2	■	(804)

↓ 48.4 mm  
 ⇔ 188.5 mm

**No.6** **1 min**

1	■	(900)
---	---	-------

↓ 24.4 mm  
 ⇔ 95.7 mm

**No.14** **3 min**

1	■	(900)
---	---	-------

↓ 32.5 mm  
 ⇔ 75.0 mm



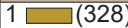

No.19

<b>19 min</b>	
1	 (328)
↓	173.7 mm
↔	194.4 mm



No.24

<b>2 min</b>	
1	 (328)
↓	47.9 mm
↔	51.4 mm



No.25

<b>1 min</b>	
1	 (869)
↓	26.0 mm
↔	57.0 mm



No.20

<b>14 min</b>	
1	 (328)
↓	137.6 mm
↔	147.2 mm



No.26

<b>2 min</b>	
1	 (007)
↓	16.8 mm
↔	92.6 mm



No.21

<b>25 min</b>	
1	 (704)
↓	154.3 mm
↔	186.5 mm







No.27

<b>1 min</b>	
1	 (005)
↓	20.7 mm
↔	33.7 mm



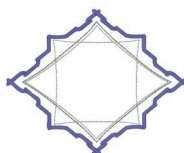

No.22

<b>7 min</b>	
1	 (900)
2	 (085)
3	 (086)
4	 (807)
↓	47.9 mm
↔	161.3 mm



No.23

<b>4 min</b>	
1	 (005)
2	 (817)
3	 (607)
↓	77.3 mm
↔	95.1 mm

- ❖ Quilt patterns
- ❖ Motifs pour quilting (courtepointe)
- ❖ Ricami per quilting
- ❖ Desenhos de acolchoados

- ❖ Quilt-Stickmuster
- ❖ Quiltontwerpen
- ❖ Diseños de acolchado



**No.1**

5 min	
1	(613)
2	(607)
↓	194.9 mm
↔	182.0 mm

**No.4**

2 min	
1	(330)
↓	194.8 mm
↔	194.9 mm

**No.2**

2 min	
1	(209)
↓	193.7 mm
↔	194.1 mm

**No.5**

2 min	
1	(406)
↓	189.7 mm
↔	189.6 mm

**No.3**

2 min	
1	(509)
↓	194.8 mm
↔	194.8 mm

**No.6**

7 min	
1	(079)
2	(086)
↓	194.8 mm
↔	194.3 mm



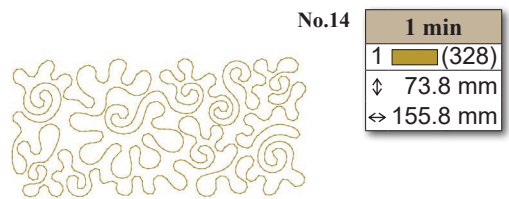
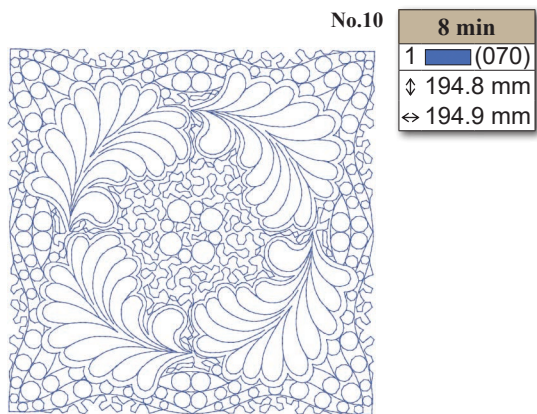
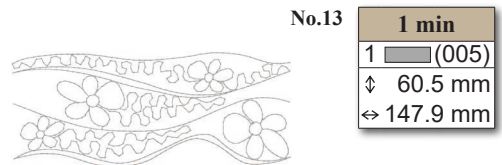
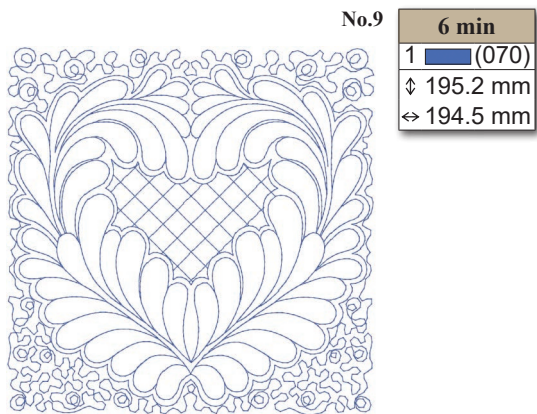
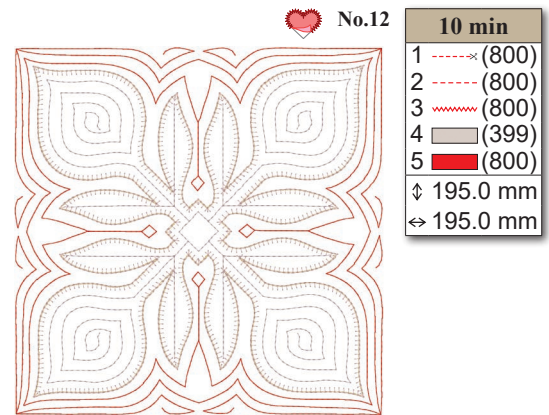
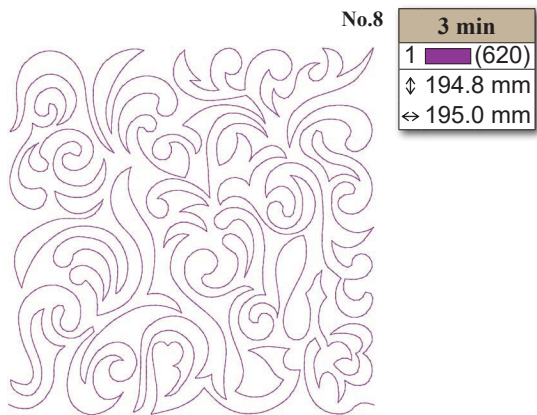
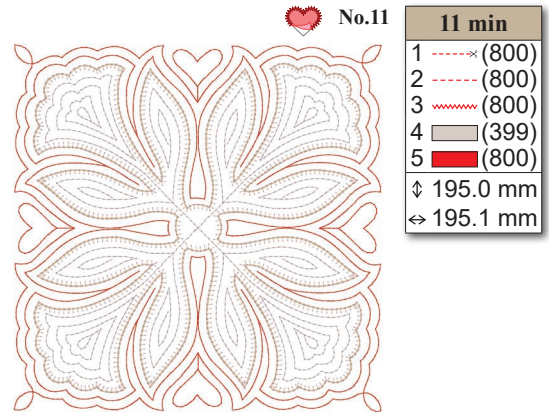
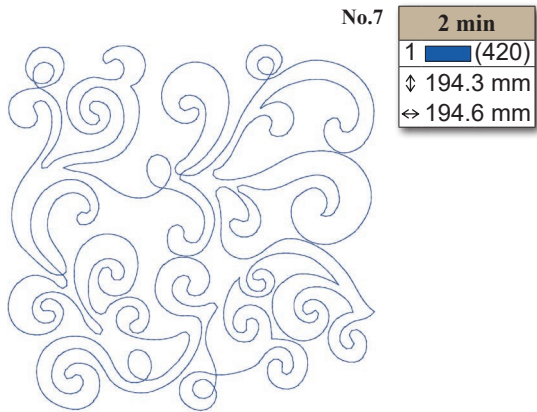

**Embroidery Patterns Color Change Table**  
**Tableau de changement de couleur des motifs de broderie**  
**Tabella dei cambi colore dei ricami**  
**Tabela de alteração de cor do padrão de bordado**

**Stickdesign-Farbtabelle**  
**Kleurenvolgorde voor de borduurontwerpen**  
**Tabla de cambios de color para diseños de bordado**

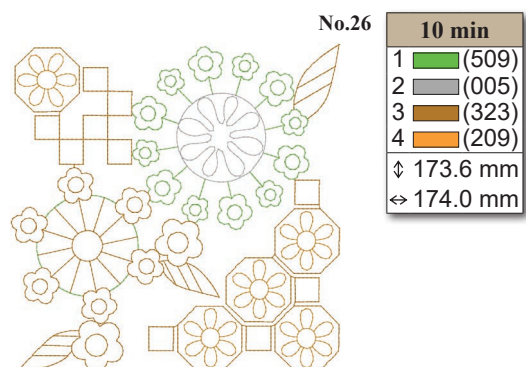
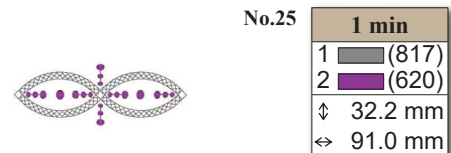
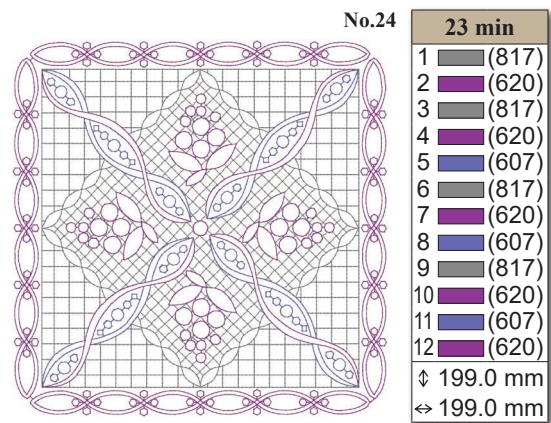
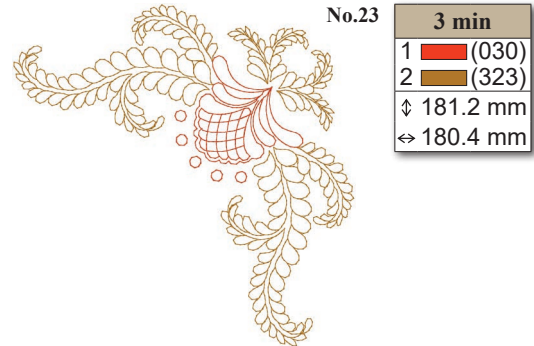
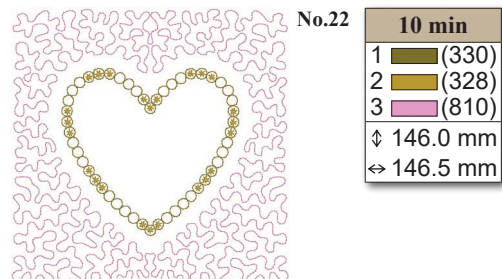
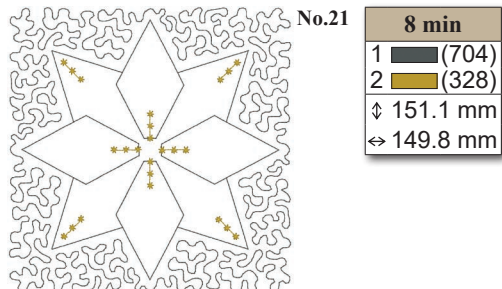
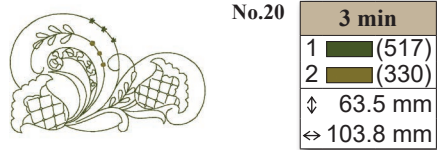
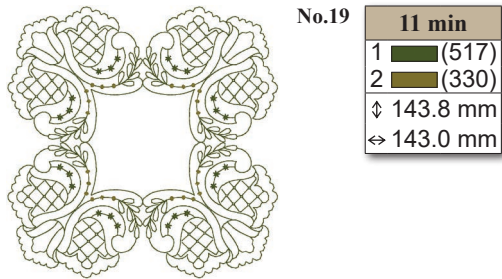
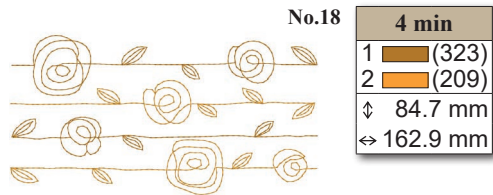
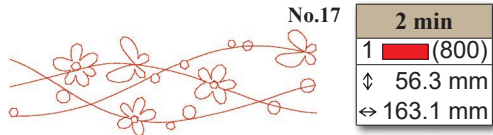

- ♥ Refer to the operation manual for the embroidery machine for details on how to embroider appliqués.
- ♥ Weitere Hinweise zum Stickten von Applikationen finden Sie in der Bedienungsanleitung der Stickmaschine.
- ♥ Reportez-vous au manuel d'instructions de la machine à broder pour plus d'informations sur la broderie des appliqués.
- ♥ Raadpleeg de bedieningshandleiding bij de borduurmachine voor gedetailleerde uitleg over het borduren van applicaties.
- ♥ Consultare il manuale di istruzioni della macchina per ricamare per i dettagli relativi al ricamo in appliqué.
- ♥ Consulte el manual de instrucciones de la máquina de bordar si desea más información sobre cómo bordar apliques.
- ♥ Consulte o manual de operações da máquina de bordar para obter detalhes sobre como bordar apliques.





**No.27**

<b>2 min</b>	
1	■ (323)
2	■ (509)
↓	180.9 mm
↔	45.3 mm

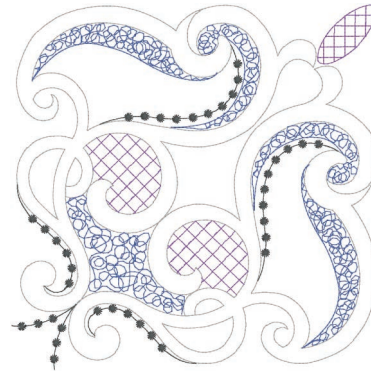

**No.32**

<b>12 min</b>	
1	■ (005)
2	■ (070)
3	■ (704)
4	■ (612)
↓	194.2 mm
↔	194.2 mm



**No.28**

<b>3 min</b>	
1	■ (517)
2	■ (208)
3	■ (800)
↓	123.9 mm
↔	59.4 mm

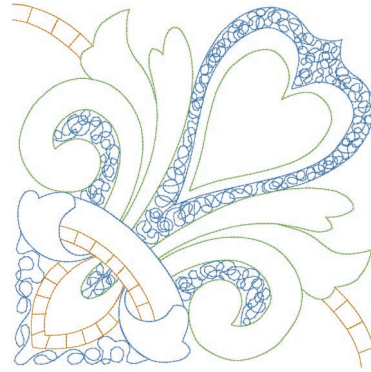

**No.33**

<b>13 min</b>	
1	■ (019)
2	■ (509)
3	■ (209)
4	■ (019)
5	■ (509)
↓	193.2 mm
↔	193.6 mm



**No.29**

<b>3 min</b>	
1	■ (214)
2	■ (330)
↓	95.3 mm
↔	83.5 mm

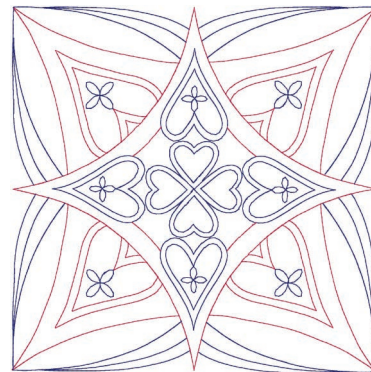

**No.34**

<b>7 min</b>	
1	■ (107)
2	■ (007)
3	■ (107)
↓	194.4 mm
↔	193.6 mm



**No.30**

<b>2 min</b>	
1	■ (330)
↓	44.2 mm
↔	162.8 mm



**No.31**

<b>11 min</b>	
1	■ (107)
2	■ (005)
3	■ (415)
4	■ (214)
↓	188.7 mm
↔	191.2 mm

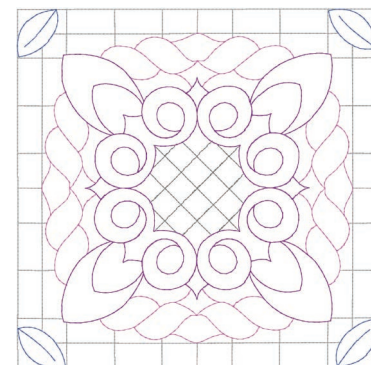

**No.35**

<b>13 min</b>	
1	■ (817)
2	■ (005)
3	■ (810)
4	■ (620)
5	■ (070)
↓	191.2 mm
↔	191.2 mm

Embroidery Patterns Color Change Table  
 Tableau de changement de couleur des motifs de broderie  
 Tabella dei cambi colore dei ricami  
 Tabela de alteração de cor do padrão de bordado

Stickdesign-Farbtabelle  
 Kleurenvogorde voor de borduurontwerpen  
 Tabla de cambios de color para diseños de bordado

- ✂ Alphabet
- ✂ Alphabet
- ✂ Alfabeto
- ✂ Alfabeto
- ✂ Buchstaben
- ✂ Lettertypen
- ✂ Alfabeto



**No.1** **9 min**



1	■ (030)
2	■ (900)
3	□ (001)
↓	68.3 mm
↔	60.2 mm

**No.7** **9 min**



1	■ (019)
2	■ (900)
3	□ (001)
↓	62.5 mm
↔	54.3 mm

**No.13** **11 min**



1	■ (612)
2	■ (900)
3	□ (001)
↓	63.5 mm
↔	68.4 mm

**No.2** **9 min**



1	■ (030)
2	■ (900)
3	□ (001)
↓	64.7 mm
↔	57.1 mm

**No.8** **8 min**



1	■ (019)
2	■ (900)
3	□ (001)
↓	64.6 mm
↔	55.9 mm

**No.14** **11 min**



1	■ (612)
2	■ (900)
3	□ (001)
↓	68.7 mm
↔	63.2 mm

**No.3** **10 min**



1	■ (030)
2	■ (900)
3	□ (001)
↓	61.3 mm
↔	55.0 mm

**No.9** **7 min**



1	■ (019)
2	■ (900)
3	□ (001)
↓	75.7 mm
↔	41.8 mm

**No.15** **7 min**



1	■ (612)
2	■ (900)
3	□ (001)
↓	69.1 mm
↔	44.5 mm

**No.4** **8 min**



1	■ (030)
2	■ (900)
3	□ (001)
↓	64.3 mm
↔	60.3 mm

**No.10** **7 min**



1	■ (019)
2	■ (900)
3	□ (001)
↓	66.2 mm
↔	48.3 mm

**No.16** **8 min**



1	■ (612)
2	■ (900)
3	□ (001)
↓	64.0 mm
↔	57.6 mm

**No.5** **9 min**



1	■ (030)
2	■ (900)
3	□ (001)
↓	68.4 mm
↔	55.1 mm

**No.11** **12 min**



1	■ (019)
2	■ (900)
3	□ (001)
↓	72.8 mm
↔	72.5 mm

**No.17** **9 min**



1	■ (509)
2	■ (900)
3	□ (001)
↓	63.7 mm
↔	53.8 mm

**No.6** **7 min**



1	■ (019)
2	■ (900)
3	□ (001)
↓	67.8 mm
↔	47.9 mm

**No.12** **7 min**



1	■ (612)
2	■ (900)
3	□ (001)
↓	71.0 mm
↔	47.8 mm

**No.18** **10 min**



1	■ (509)
2	■ (900)
3	□ (001)
↓	64.6 mm
↔	58.1 mm

**No.19** 8 min



1	█ (509)
2	█ (900)
3	□ (001)
↓	64.6 mm
↔	50.2 mm

**No.22** 9 min



1	█ (509)
2	█ (900)
3	□ (001)
↓	71.1 mm
↔	60.7 mm

**No.25** 9 min



1	█ (817)
2	█ (900)
3	□ (001)
↓	67.9 mm
↔	50.7 mm

**No.20** 7 min



1	█ (509)
2	█ (900)
3	□ (001)
↓	62.9 mm
↔	52.5 mm

**No.23** 12 min



1	█ (817)
2	█ (900)
3	□ (001)
↓	66.9 mm
↔	74.9 mm

**No.26** 10 min



1	█ (817)
2	█ (900)
3	□ (001)
↓	67.8 mm
↔	63.8 mm

**No.21** 9 min



1	█ (509)
2	█ (900)
3	□ (001)
↓	64.8 mm
↔	50.1 mm

**No.24** 10 min



1	█ (817)
2	█ (900)
3	□ (001)
↓	74.9 mm
↔	67.9 mm



**No.1** 9 min

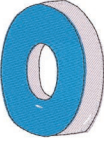

1	█ (399)
2	█ (019)
3	█ (900)
4	□ (001)
↓	71.5 mm
↔	55.1 mm

**No.5** 7 min



1	█ (405)
2	█ (900)
3	□ (001)
↓	73.8 mm
↔	54.8 mm

**No.9** 7 min



1	█ (019)
2	█ (900)
3	□ (001)
↓	74.6 mm
↔	43.9 mm

**No.2** 6 min



1	█ (208)
2	█ (900)
3	□ (001)
↓	72.5 mm
↔	40.8 mm

**No.6** 8 min



1	█ (612)
2	█ (900)
3	□ (001)
↓	70.8 mm
↔	52.3 mm

**No.10** 6 min



1	█ (800)
2	█ (900)
3	□ (001)
↓	72.7 mm
↔	47.6 mm

**No.3** 7 min



1	█ (509)
2	█ (900)
3	□ (001)
↓	70.6 mm
↔	52.4 mm

**No.7** 7 min



1	█ (126)
2	█ (900)
3	□ (001)
↓	72.2 mm
↔	56.4 mm

**No.4** 8 min



1	█ (005)
2	█ (900)
3	□ (001)
↓	67.7 mm
↔	51.4 mm

**No.8** 6 min



1	█ (205)
2	█ (900)
3	□ (001)
↓	69.5 mm
↔	58.4 mm

Embroidery Patterns Color Change Table  
 Tableau de changement de couleur des motifs de broderie  
 Tabella dei cambi colore dei ricami  
 Tabela de alteração de cor do padrão de bordado

Stickdesign-Farbtabelle  
 Kleurenvolgeorde voor de borduurontwerpen  
 Tabla de cambios de color para diseños de bordado

- Vintage
- Retro
- Vintage

- Vintage
- Vintage

- Classique
- Antiquo



<p>No.1</p> 	<table border="1" style="width: 100%; border-collapse: collapse;"> <tr><td style="text-align: center;"><b>17 min</b></td></tr> <tr><td style="text-align: center;">1  (323)</td></tr> <tr><td style="text-align: center;">↓ 148.0 mm</td></tr> <tr><td style="text-align: center;">↔ 129.6 mm</td></tr> </table>	<b>17 min</b>	1  (323)	↓ 148.0 mm	↔ 129.6 mm	<p>No.6</p> 	<table border="1" style="width: 100%; border-collapse: collapse;"> <tr><td style="text-align: center;"><b>16 min</b></td></tr> <tr><td style="text-align: center;">1  (323)</td></tr> <tr><td style="text-align: center;">↓ 149.3 mm</td></tr> <tr><td style="text-align: center;">↔ 107.4 mm</td></tr> </table>	<b>16 min</b>	1  (323)	↓ 149.3 mm	↔ 107.4 mm	<p>No.11</p> 	<table border="1" style="width: 100%; border-collapse: collapse;"> <tr><td style="text-align: center;"><b>21 min</b></td></tr> <tr><td style="text-align: center;">1  (323)</td></tr> <tr><td style="text-align: center;">↓ 149.4 mm</td></tr> <tr><td style="text-align: center;">↔ 125.1 mm</td></tr> </table>	<b>21 min</b>	1  (323)	↓ 149.4 mm	↔ 125.1 mm
<b>17 min</b>																	
1  (323)																	
↓ 148.0 mm																	
↔ 129.6 mm																	
<b>16 min</b>																	
1  (323)																	
↓ 149.3 mm																	
↔ 107.4 mm																	
<b>21 min</b>																	
1  (323)																	
↓ 149.4 mm																	
↔ 125.1 mm																	
<p>No.2</p> 	<table border="1" style="width: 100%; border-collapse: collapse;"> <tr><td style="text-align: center;"><b>18 min</b></td></tr> <tr><td style="text-align: center;">1  (323)</td></tr> <tr><td style="text-align: center;">↓ 149.9 mm</td></tr> <tr><td style="text-align: center;">↔ 110.9 mm</td></tr> </table>	<b>18 min</b>	1  (323)	↓ 149.9 mm	↔ 110.9 mm	<p>No.7</p> 	<table border="1" style="width: 100%; border-collapse: collapse;"> <tr><td style="text-align: center;"><b>18 min</b></td></tr> <tr><td style="text-align: center;">1  (323)</td></tr> <tr><td style="text-align: center;">↓ 150.4 mm</td></tr> <tr><td style="text-align: center;">↔ 111.7 mm</td></tr> </table>	<b>18 min</b>	1  (323)	↓ 150.4 mm	↔ 111.7 mm	<p>No.12</p> 	<table border="1" style="width: 100%; border-collapse: collapse;"> <tr><td style="text-align: center;"><b>13 min</b></td></tr> <tr><td style="text-align: center;">1  (323)</td></tr> <tr><td style="text-align: center;">↓ 149.2 mm</td></tr> <tr><td style="text-align: center;">↔ 107.1 mm</td></tr> </table>	<b>13 min</b>	1  (323)	↓ 149.2 mm	↔ 107.1 mm
<b>18 min</b>																	
1  (323)																	
↓ 149.9 mm																	
↔ 110.9 mm																	
<b>18 min</b>																	
1  (323)																	
↓ 150.4 mm																	
↔ 111.7 mm																	
<b>13 min</b>																	
1  (323)																	
↓ 149.2 mm																	
↔ 107.1 mm																	
<p>No.3</p> 	<table border="1" style="width: 100%; border-collapse: collapse;"> <tr><td style="text-align: center;"><b>14 min</b></td></tr> <tr><td style="text-align: center;">1  (323)</td></tr> <tr><td style="text-align: center;">↓ 152.9 mm</td></tr> <tr><td style="text-align: center;">↔ 102.3 mm</td></tr> </table>	<b>14 min</b>	1  (323)	↓ 152.9 mm	↔ 102.3 mm	<p>No.8</p> 	<table border="1" style="width: 100%; border-collapse: collapse;"> <tr><td style="text-align: center;"><b>21 min</b></td></tr> <tr><td style="text-align: center;">1  (323)</td></tr> <tr><td style="text-align: center;">↓ 149.1 mm</td></tr> <tr><td style="text-align: center;">↔ 125.6 mm</td></tr> </table>	<b>21 min</b>	1  (323)	↓ 149.1 mm	↔ 125.6 mm	<p>No.13</p> 	<table border="1" style="width: 100%; border-collapse: collapse;"> <tr><td style="text-align: center;"><b>28 min</b></td></tr> <tr><td style="text-align: center;">1  (323)</td></tr> <tr><td style="text-align: center;">↓ 149.2 mm</td></tr> <tr><td style="text-align: center;">↔ 150.1 mm</td></tr> </table>	<b>28 min</b>	1  (323)	↓ 149.2 mm	↔ 150.1 mm
<b>14 min</b>																	
1  (323)																	
↓ 152.9 mm																	
↔ 102.3 mm																	
<b>21 min</b>																	
1  (323)																	
↓ 149.1 mm																	
↔ 125.6 mm																	
<b>28 min</b>																	
1  (323)																	
↓ 149.2 mm																	
↔ 150.1 mm																	
<p>No.4</p> 	<table border="1" style="width: 100%; border-collapse: collapse;"> <tr><td style="text-align: center;"><b>18 min</b></td></tr> <tr><td style="text-align: center;">1  (323)</td></tr> <tr><td style="text-align: center;">↓ 149.3 mm</td></tr> <tr><td style="text-align: center;">↔ 111.7 mm</td></tr> </table>	<b>18 min</b>	1  (323)	↓ 149.3 mm	↔ 111.7 mm	<p>No.9</p> 	<table border="1" style="width: 100%; border-collapse: collapse;"> <tr><td style="text-align: center;"><b>10 min</b></td></tr> <tr><td style="text-align: center;">1  (323)</td></tr> <tr><td style="text-align: center;">↓ 149.1 mm</td></tr> <tr><td style="text-align: center;">↔ 58.0 mm</td></tr> </table>	<b>10 min</b>	1  (323)	↓ 149.1 mm	↔ 58.0 mm	<p>No.14</p> 	<table border="1" style="width: 100%; border-collapse: collapse;"> <tr><td style="text-align: center;"><b>21 min</b></td></tr> <tr><td style="text-align: center;">1  (323)</td></tr> <tr><td style="text-align: center;">↓ 149.7 mm</td></tr> <tr><td style="text-align: center;">↔ 131.1 mm</td></tr> </table>	<b>21 min</b>	1  (323)	↓ 149.7 mm	↔ 131.1 mm
<b>18 min</b>																	
1  (323)																	
↓ 149.3 mm																	
↔ 111.7 mm																	
<b>10 min</b>																	
1  (323)																	
↓ 149.1 mm																	
↔ 58.0 mm																	
<b>21 min</b>																	
1  (323)																	
↓ 149.7 mm																	
↔ 131.1 mm																	
<p>No.5</p> 	<table border="1" style="width: 100%; border-collapse: collapse;"> <tr><td style="text-align: center;"><b>19 min</b></td></tr> <tr><td style="text-align: center;">1  (323)</td></tr> <tr><td style="text-align: center;">↓ 149.1 mm</td></tr> <tr><td style="text-align: center;">↔ 109.7 mm</td></tr> </table>	<b>19 min</b>	1  (323)	↓ 149.1 mm	↔ 109.7 mm	<p>No.10</p> 	<table border="1" style="width: 100%; border-collapse: collapse;"> <tr><td style="text-align: center;"><b>11 min</b></td></tr> <tr><td style="text-align: center;">1  (323)</td></tr> <tr><td style="text-align: center;">↓ 148.8 mm</td></tr> <tr><td style="text-align: center;">↔ 93.9 mm</td></tr> </table>	<b>11 min</b>	1  (323)	↓ 148.8 mm	↔ 93.9 mm	<p>No.15</p> 	<table border="1" style="width: 100%; border-collapse: collapse;"> <tr><td style="text-align: center;"><b>19 min</b></td></tr> <tr><td style="text-align: center;">1  (323)</td></tr> <tr><td style="text-align: center;">↓ 151.7 mm</td></tr> <tr><td style="text-align: center;">↔ 107.1 mm</td></tr> </table>	<b>19 min</b>	1  (323)	↓ 151.7 mm	↔ 107.1 mm
<b>19 min</b>																	
1  (323)																	
↓ 149.1 mm																	
↔ 109.7 mm																	
<b>11 min</b>																	
1  (323)																	
↓ 148.8 mm																	
↔ 93.9 mm																	
<b>19 min</b>																	
1  (323)																	
↓ 151.7 mm																	
↔ 107.1 mm																	



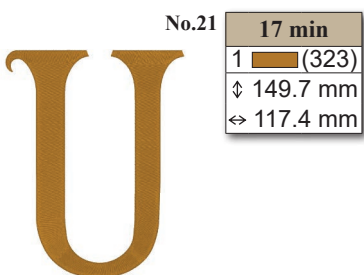
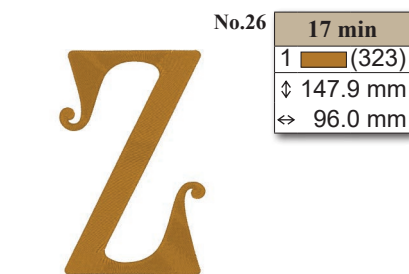
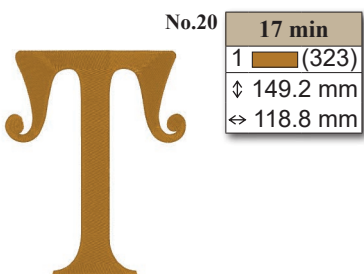
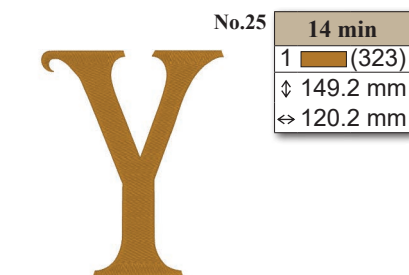
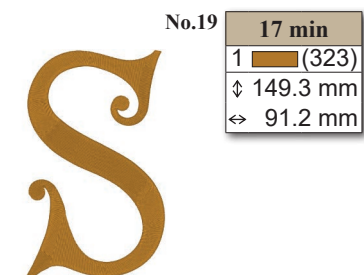
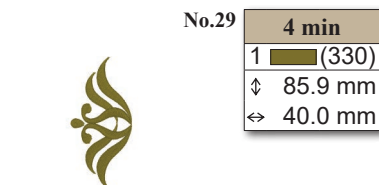
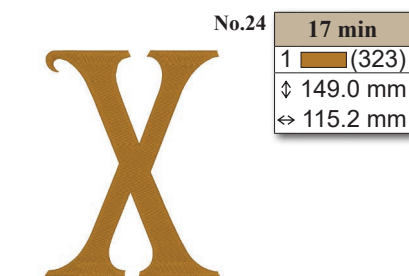
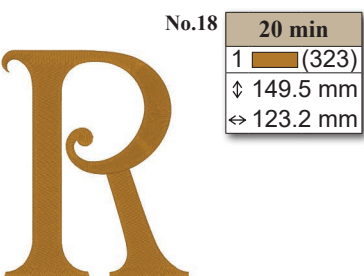
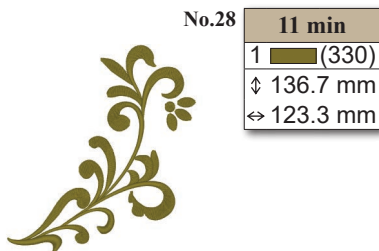
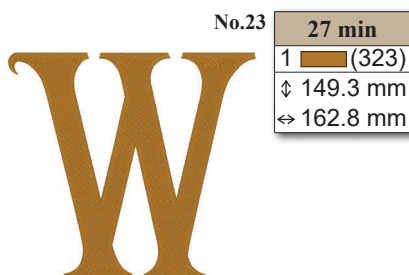
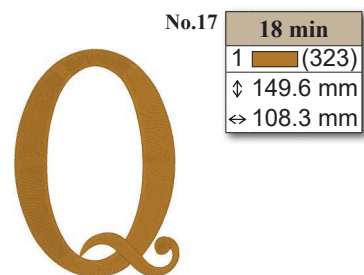
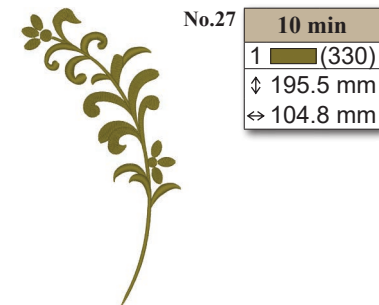
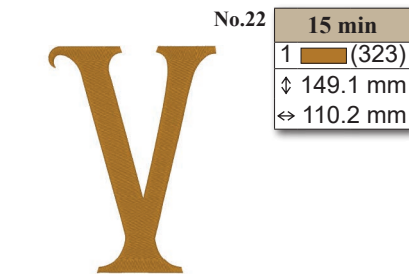
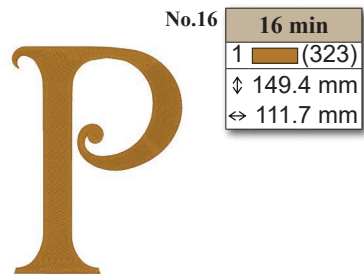



Embroidery Patterns Color Change Table  
 Tableau de changement de couleur des motifs de broderie  
 Tabella dei cambi colore dei ricami  
 Tabela de alteração de cor do padrão de bordado

Stickdesign-Farbtabelle  
 Kleurenvolgeorde voor de borduurontwerpen  
 Tabla de cambios de color para diseños de bordado

- Floral
- Bloemen
- Blumen
- Floreale
- Floral
- Floral



<p><b>No.1</b> <b>17 min</b></p> <table border="1" style="width: 100%; border-collapse: collapse; text-align: center;"> <tr><td>1</td><td>■ (328)</td></tr> <tr><td>2</td><td>■ (804)</td></tr> <tr><td>3</td><td>■ (612)</td></tr> <tr><td>4</td><td>■ (079)</td></tr> <tr><td>5</td><td>■ (807)</td></tr> <tr><td>6</td><td>■ (513)</td></tr> <tr><td>7</td><td>■ (502)</td></tr> </table> <p>↓ 145.1 mm ↔ 125.7 mm</p>	1	■ (328)	2	■ (804)	3	■ (612)	4	■ (079)	5	■ (807)	6	■ (513)	7	■ (502)	<p><b>No.6</b> <b>16 min</b></p> <table border="1" style="width: 100%; border-collapse: collapse; text-align: center;"> <tr><td>1</td><td>■ (328)</td></tr> <tr><td>2</td><td>■ (804)</td></tr> <tr><td>3</td><td>■ (612)</td></tr> <tr><td>4</td><td>■ (079)</td></tr> <tr><td>5</td><td>■ (807)</td></tr> <tr><td>6</td><td>■ (513)</td></tr> <tr><td>7</td><td>■ (502)</td></tr> </table> <p>↓ 142.8 mm ↔ 101.8 mm</p>	1	■ (328)	2	■ (804)	3	■ (612)	4	■ (079)	5	■ (807)	6	■ (513)	7	■ (502)	<p><b>No.11</b> <b>20 min</b></p> <table border="1" style="width: 100%; border-collapse: collapse; text-align: center;"> <tr><td>1</td><td>■ (328)</td></tr> <tr><td>2</td><td>■ (804)</td></tr> <tr><td>3</td><td>■ (612)</td></tr> <tr><td>4</td><td>■ (079)</td></tr> <tr><td>5</td><td>■ (807)</td></tr> <tr><td>6</td><td>■ (513)</td></tr> <tr><td>7</td><td>■ (502)</td></tr> </table> <p>↓ 142.0 mm ↔ 119.6 mm</p>	1	■ (328)	2	■ (804)	3	■ (612)	4	■ (079)	5	■ (807)	6	■ (513)	7	■ (502)
1	■ (328)																																											
2	■ (804)																																											
3	■ (612)																																											
4	■ (079)																																											
5	■ (807)																																											
6	■ (513)																																											
7	■ (502)																																											
1	■ (328)																																											
2	■ (804)																																											
3	■ (612)																																											
4	■ (079)																																											
5	■ (807)																																											
6	■ (513)																																											
7	■ (502)																																											
1	■ (328)																																											
2	■ (804)																																											
3	■ (612)																																											
4	■ (079)																																											
5	■ (807)																																											
6	■ (513)																																											
7	■ (502)																																											
<p><b>No.2</b> <b>20 min</b></p> <table border="1" style="width: 100%; border-collapse: collapse; text-align: center;"> <tr><td>1</td><td>■ (328)</td></tr> <tr><td>2</td><td>■ (804)</td></tr> <tr><td>3</td><td>■ (612)</td></tr> <tr><td>4</td><td>■ (079)</td></tr> <tr><td>5</td><td>■ (807)</td></tr> <tr><td>6</td><td>■ (513)</td></tr> <tr><td>7</td><td>■ (502)</td></tr> </table> <p>↓ 140.9 mm ↔ 108.1 mm</p>	1	■ (328)	2	■ (804)	3	■ (612)	4	■ (079)	5	■ (807)	6	■ (513)	7	■ (502)	<p><b>No.7</b> <b>19 min</b></p> <table border="1" style="width: 100%; border-collapse: collapse; text-align: center;"> <tr><td>1</td><td>■ (328)</td></tr> <tr><td>2</td><td>■ (804)</td></tr> <tr><td>3</td><td>■ (612)</td></tr> <tr><td>4</td><td>■ (079)</td></tr> <tr><td>5</td><td>■ (807)</td></tr> <tr><td>6</td><td>■ (513)</td></tr> <tr><td>7</td><td>■ (502)</td></tr> </table> <p>↓ 141.6 mm ↔ 117.3 mm</p>	1	■ (328)	2	■ (804)	3	■ (612)	4	■ (079)	5	■ (807)	6	■ (513)	7	■ (502)	<p><b>No.12</b> <b>15 min</b></p> <table border="1" style="width: 100%; border-collapse: collapse; text-align: center;"> <tr><td>1</td><td>■ (328)</td></tr> <tr><td>2</td><td>■ (804)</td></tr> <tr><td>3</td><td>■ (612)</td></tr> <tr><td>4</td><td>■ (079)</td></tr> <tr><td>5</td><td>■ (807)</td></tr> <tr><td>6</td><td>■ (513)</td></tr> <tr><td>7</td><td>■ (502)</td></tr> </table> <p>↓ 144.9 mm ↔ 107.0 mm</p>	1	■ (328)	2	■ (804)	3	■ (612)	4	■ (079)	5	■ (807)	6	■ (513)	7	■ (502)
1	■ (328)																																											
2	■ (804)																																											
3	■ (612)																																											
4	■ (079)																																											
5	■ (807)																																											
6	■ (513)																																											
7	■ (502)																																											
1	■ (328)																																											
2	■ (804)																																											
3	■ (612)																																											
4	■ (079)																																											
5	■ (807)																																											
6	■ (513)																																											
7	■ (502)																																											
1	■ (328)																																											
2	■ (804)																																											
3	■ (612)																																											
4	■ (079)																																											
5	■ (807)																																											
6	■ (513)																																											
7	■ (502)																																											
<p><b>No.3</b> <b>17 min</b></p> <table border="1" style="width: 100%; border-collapse: collapse; text-align: center;"> <tr><td>1</td><td>■ (328)</td></tr> <tr><td>2</td><td>■ (804)</td></tr> <tr><td>3</td><td>■ (612)</td></tr> <tr><td>4</td><td>■ (079)</td></tr> <tr><td>5</td><td>■ (807)</td></tr> <tr><td>6</td><td>■ (513)</td></tr> <tr><td>7</td><td>■ (502)</td></tr> </table> <p>↓ 141.8 mm ↔ 114.5 mm</p>	1	■ (328)	2	■ (804)	3	■ (612)	4	■ (079)	5	■ (807)	6	■ (513)	7	■ (502)	<p><b>No.8</b> <b>22 min</b></p> <table border="1" style="width: 100%; border-collapse: collapse; text-align: center;"> <tr><td>1</td><td>■ (328)</td></tr> <tr><td>2</td><td>■ (804)</td></tr> <tr><td>3</td><td>■ (612)</td></tr> <tr><td>4</td><td>■ (079)</td></tr> <tr><td>5</td><td>■ (807)</td></tr> <tr><td>6</td><td>■ (513)</td></tr> <tr><td>7</td><td>■ (502)</td></tr> </table> <p>↓ 141.7 mm ↔ 121.6 mm</p>	1	■ (328)	2	■ (804)	3	■ (612)	4	■ (079)	5	■ (807)	6	■ (513)	7	■ (502)	<p><b>No.13</b> <b>23 min</b></p> <table border="1" style="width: 100%; border-collapse: collapse; text-align: center;"> <tr><td>1</td><td>■ (328)</td></tr> <tr><td>2</td><td>■ (804)</td></tr> <tr><td>3</td><td>■ (612)</td></tr> <tr><td>4</td><td>■ (079)</td></tr> <tr><td>5</td><td>■ (807)</td></tr> <tr><td>6</td><td>■ (513)</td></tr> <tr><td>7</td><td>■ (502)</td></tr> </table> <p>↓ 146.5 mm ↔ 124.6 mm</p>	1	■ (328)	2	■ (804)	3	■ (612)	4	■ (079)	5	■ (807)	6	■ (513)	7	■ (502)
1	■ (328)																																											
2	■ (804)																																											
3	■ (612)																																											
4	■ (079)																																											
5	■ (807)																																											
6	■ (513)																																											
7	■ (502)																																											
1	■ (328)																																											
2	■ (804)																																											
3	■ (612)																																											
4	■ (079)																																											
5	■ (807)																																											
6	■ (513)																																											
7	■ (502)																																											
1	■ (328)																																											
2	■ (804)																																											
3	■ (612)																																											
4	■ (079)																																											
5	■ (807)																																											
6	■ (513)																																											
7	■ (502)																																											
<p><b>No.4</b> <b>19 min</b></p> <table border="1" style="width: 100%; border-collapse: collapse; text-align: center;"> <tr><td>1</td><td>■ (328)</td></tr> <tr><td>2</td><td>■ (804)</td></tr> <tr><td>3</td><td>■ (612)</td></tr> <tr><td>4</td><td>■ (079)</td></tr> <tr><td>5</td><td>■ (807)</td></tr> <tr><td>6</td><td>■ (513)</td></tr> <tr><td>7</td><td>■ (502)</td></tr> </table> <p>↓ 141.2 mm ↔ 108.3 mm</p>	1	■ (328)	2	■ (804)	3	■ (612)	4	■ (079)	5	■ (807)	6	■ (513)	7	■ (502)	<p><b>No.9</b> <b>14 min</b></p> <table border="1" style="width: 100%; border-collapse: collapse; text-align: center;"> <tr><td>1</td><td>■ (328)</td></tr> <tr><td>2</td><td>■ (804)</td></tr> <tr><td>3</td><td>■ (612)</td></tr> <tr><td>4</td><td>■ (079)</td></tr> <tr><td>5</td><td>■ (807)</td></tr> <tr><td>6</td><td>■ (513)</td></tr> <tr><td>7</td><td>■ (502)</td></tr> </table> <p>↓ 145.8 mm ↔ 49.7 mm</p>	1	■ (328)	2	■ (804)	3	■ (612)	4	■ (079)	5	■ (807)	6	■ (513)	7	■ (502)	<p><b>No.14</b> <b>20 min</b></p> <table border="1" style="width: 100%; border-collapse: collapse; text-align: center;"> <tr><td>1</td><td>■ (328)</td></tr> <tr><td>2</td><td>■ (804)</td></tr> <tr><td>3</td><td>■ (612)</td></tr> <tr><td>4</td><td>■ (079)</td></tr> <tr><td>5</td><td>■ (807)</td></tr> <tr><td>6</td><td>■ (513)</td></tr> <tr><td>7</td><td>■ (502)</td></tr> </table> <p>↓ 147.0 mm ↔ 116.8 mm</p>	1	■ (328)	2	■ (804)	3	■ (612)	4	■ (079)	5	■ (807)	6	■ (513)	7	■ (502)
1	■ (328)																																											
2	■ (804)																																											
3	■ (612)																																											
4	■ (079)																																											
5	■ (807)																																											
6	■ (513)																																											
7	■ (502)																																											
1	■ (328)																																											
2	■ (804)																																											
3	■ (612)																																											
4	■ (079)																																											
5	■ (807)																																											
6	■ (513)																																											
7	■ (502)																																											
1	■ (328)																																											
2	■ (804)																																											
3	■ (612)																																											
4	■ (079)																																											
5	■ (807)																																											
6	■ (513)																																											
7	■ (502)																																											
<p><b>No.5</b> <b>18 min</b></p> <table border="1" style="width: 100%; border-collapse: collapse; text-align: center;"> <tr><td>1</td><td>■ (328)</td></tr> <tr><td>2</td><td>■ (804)</td></tr> <tr><td>3</td><td>■ (612)</td></tr> <tr><td>4</td><td>■ (079)</td></tr> <tr><td>5</td><td>■ (807)</td></tr> <tr><td>6</td><td>■ (513)</td></tr> <tr><td>7</td><td>■ (502)</td></tr> </table> <p>↓ 144.3 mm ↔ 102.5 mm</p>	1	■ (328)	2	■ (804)	3	■ (612)	4	■ (079)	5	■ (807)	6	■ (513)	7	■ (502)	<p><b>No.10</b> <b>15 min</b></p> <table border="1" style="width: 100%; border-collapse: collapse; text-align: center;"> <tr><td>1</td><td>■ (328)</td></tr> <tr><td>2</td><td>■ (804)</td></tr> <tr><td>3</td><td>■ (612)</td></tr> <tr><td>4</td><td>■ (079)</td></tr> <tr><td>5</td><td>■ (807)</td></tr> <tr><td>6</td><td>■ (513)</td></tr> <tr><td>7</td><td>■ (502)</td></tr> </table> <p>↓ 144.5 mm ↔ 82.3 mm</p>	1	■ (328)	2	■ (804)	3	■ (612)	4	■ (079)	5	■ (807)	6	■ (513)	7	■ (502)	<p><b>No.15</b> <b>19 min</b></p> <table border="1" style="width: 100%; border-collapse: collapse; text-align: center;"> <tr><td>1</td><td>■ (328)</td></tr> <tr><td>2</td><td>■ (804)</td></tr> <tr><td>3</td><td>■ (612)</td></tr> <tr><td>4</td><td>■ (079)</td></tr> <tr><td>5</td><td>■ (807)</td></tr> <tr><td>6</td><td>■ (513)</td></tr> <tr><td>7</td><td>■ (502)</td></tr> </table> <p>↓ 146.3 mm ↔ 115.3 mm</p>	1	■ (328)	2	■ (804)	3	■ (612)	4	■ (079)	5	■ (807)	6	■ (513)	7	■ (502)
1	■ (328)																																											
2	■ (804)																																											
3	■ (612)																																											
4	■ (079)																																											
5	■ (807)																																											
6	■ (513)																																											
7	■ (502)																																											
1	■ (328)																																											
2	■ (804)																																											
3	■ (612)																																											
4	■ (079)																																											
5	■ (807)																																											
6	■ (513)																																											
7	■ (502)																																											
1	■ (328)																																											
2	■ (804)																																											
3	■ (612)																																											
4	■ (079)																																											
5	■ (807)																																											
6	■ (513)																																											
7	■ (502)																																											

**No.16** **17 min**



1	(328)
2	(804)
3	(612)
4	(079)
5	(807)
6	(513)
7	(502)

↓ 143.4 mm  
↔ 99.6 mm

**No.20** **18 min**



1	(328)
2	(804)
3	(612)
4	(079)
5	(807)
6	(513)
7	(502)

↓ 144.5 mm  
↔ 118.4 mm

**No.24** **19 min**



1	(328)
2	(804)
3	(612)
4	(079)
5	(807)
6	(513)
7	(502)

↓ 142.3 mm  
↔ 115.9 mm

**No.17** **20 min**



1	(328)
2	(804)
3	(612)
4	(079)
5	(807)
6	(513)
7	(502)

↓ 142.7 mm  
↔ 118.2 mm

**No.21** **18 min**



1	(328)
2	(804)
3	(612)
4	(079)
5	(807)
6	(513)
7	(502)

↓ 144.6 mm  
↔ 118.5 mm

**No.25** **17 min**



1	(328)
2	(804)
3	(612)
4	(079)
5	(807)
6	(513)
7	(502)

↓ 142.8 mm  
↔ 116.3 mm

**No.18** **21 min**



1	(328)
2	(804)
3	(612)
4	(079)
5	(807)
6	(513)
7	(502)

↓ 143.4 mm  
↔ 112.5 mm

**No.22** **17 min**



1	(328)
2	(804)
3	(612)
4	(079)
5	(807)
6	(513)
7	(502)

↓ 145.5 mm  
↔ 121.5 mm

**No.26** **19 min**



1	(328)
2	(804)
3	(612)
4	(079)
5	(807)
6	(513)
7	(502)

↓ 142.8 mm  
↔ 92.9 mm

**No.19** **21 min**



1	(328)
2	(804)
3	(612)
4	(079)
5	(807)
6	(513)
7	(502)

↓ 144.1 mm  
↔ 99.4 mm

**No.23** **23 min**



1	(328)
2	(804)
3	(612)
4	(079)
5	(807)
6	(513)
7	(502)

↓ 146.2 mm  
↔ 124.8 mm

◆Example ◆Beispiel ◆Exemple ◆Voorbeeld  
◆Esempio ◆Ejemplo ◆Example

**No.27** **3 min**



1	(328)
2	(804)
3	(612)
4	(079)
5	(807)

↓ 51.9 mm  
↔ 45.9 mm

**No.29** **3 min**



1	(328)
2	(804)
3	(612)
4	(079)
5	(807)

↓ 52.2 mm  
↔ 41.1 mm

**No.31** **3 min**



1	(328)
2	(804)
3	(612)
4	(079)
5	(807)

↓ 53.1 mm  
↔ 37.3 mm

**No.28** **3 min**



1	(328)
2	(804)
3	(612)
4	(079)
5	(807)

↓ 51.7 mm  
↔ 39.6 mm

**No.30** **3 min**



1	(328)
2	(804)
3	(612)
4	(079)
5	(807)

↓ 51.9 mm  
↔ 39.3 mm

**No.32** **3 min**



1	(328)
2	(804)
3	(612)
4	(079)
5	(807)

↓ 52.1 mm  
↔ 36.6 mm

**No.32** **3 min**



1	(328)
2	(804)
3	(612)
4	(079)
5	(807)

↓ 52.1 mm  
↔ 36.6 mm

**Embroidery Patterns Color Change Table**  
**Tableau de changement de couleur des motifs de broderie**  
**Tabella dei cambi colore dei ricami**  
**Tabela de alteração de cor do padrão de bordado**

**Stickdesign-Farbtabelle**  
**Kleurenvolgorde voor de borduurontwerpen**  
**Tabla de cambios de color para diseños de bordado**

**No.33** **3 min**



1	■ (328)
2	■ (079)
3	■ (807)
4	■ (513)
5	■ (502)

↓ 51.9 mm  
↔ 42.7 mm

**No.38** **3 min**



1	■ (328)
2	■ (079)
3	■ (807)
4	■ (513)
5	■ (502)

↓ 52.5 mm  
↔ 38.9 mm

**No.43** **3 min**



1	■ (328)
2	■ (079)
3	■ (807)
4	■ (513)
5	■ (502)

↓ 52.6 mm  
↔ 43.3 mm

**No.48** **3 min**



1	■ (328)
2	■ (079)
3	■ (807)
4	■ (513)
5	■ (502)

↓ 52.8 mm  
↔ 43.9 mm

**No.34** **4 min**



1	■ (328)
2	■ (079)
3	■ (807)
4	■ (513)
5	■ (502)

↓ 52.2 mm  
↔ 44.3 mm

**No.39** **5 min**



1	■ (328)
2	■ (079)
3	■ (807)
4	■ (513)
5	■ (502)

↓ 53.3 mm  
↔ 46.4 mm

**No.44** **4 min**



1	■ (328)
2	■ (079)
3	■ (807)
4	■ (513)
5	■ (502)

↓ 52.3 mm  
↔ 40.7 mm

**No.49** **4 min**



1	■ (328)
2	■ (079)
3	■ (807)
4	■ (513)
5	■ (502)

↓ 53.3 mm  
↔ 46.5 mm

**No.35** **3 min**



1	■ (328)
2	■ (079)
3	■ (807)
4	■ (513)
5	■ (502)

↓ 53.9 mm  
↔ 23.8 mm

**No.40** **4 min**



1	■ (328)
2	■ (079)
3	■ (807)
4	■ (513)
5	■ (502)

↓ 52.9 mm  
↔ 43.1 mm

**No.45** **3 min**



1	■ (328)
2	■ (079)
3	■ (807)
4	■ (513)
5	■ (502)

↓ 52.6 mm  
↔ 35.0 mm

**No.50** **3 min**



1	■ (328)
2	■ (079)
3	■ (807)
4	■ (513)
5	■ (502)

↓ 51.7 mm  
↔ 42.0 mm

**No.36** **3 min**



1	■ (328)
2	■ (079)
3	■ (807)
4	■ (513)
5	■ (502)

↓ 52.6 mm  
↔ 30.1 mm

**No.41** **3 min**



1	■ (328)
2	■ (079)
3	■ (807)
4	■ (513)
5	■ (502)

↓ 52.8 mm  
↔ 42.6 mm

**No.46** **3 min**



1	■ (328)
2	■ (079)
3	■ (807)
4	■ (513)
5	■ (502)

↓ 53.0 mm  
↔ 42.0 mm

**No.51** **3 min**



1	■ (328)
2	■ (079)
3	■ (807)
4	■ (513)
5	■ (502)

↓ 53.8 mm  
↔ 42.2 mm

**No.37** **4 min**



1	■ (328)
2	■ (079)
3	■ (807)
4	■ (513)
5	■ (502)

↓ 52.4 mm  
↔ 43.4 mm

**No.42** **3 min**



1	■ (328)
2	■ (079)
3	■ (807)
4	■ (513)
5	■ (502)

↓ 52.1 mm  
↔ 36.9 mm

**No.47** **3 min**



1	■ (328)
2	■ (079)
3	■ (807)
4	■ (513)
5	■ (502)

↓ 52.5 mm  
↔ 42.8 mm

**No.52** **3 min**



1	■ (328)
2	■ (079)
3	■ (807)
4	■ (513)
5	■ (502)

↓ 52.4 mm  
↔ 33.4 mm

**No.53** **2 min**



1	■ (804)
2	■ (612)
3	■ (079)
4	■ (807)
5	■ (513)
6	■ (502)

↓ 34.4 mm  
↔ 22.7 mm



**3 min**

1	■ (804)	3	■ (079)	5	■ (513)
2	■ (612)	4	■ (807)	6	■ (502)

↓ 39.3 mm ↔ 75.4 mm



**6 min**

1	■ (804)	7	■ (804)	13	■ (079)
2	■ (612)	8	■ (612)	14	■ (807)
3	■ (079)	9	■ (079)	15	■ (513)
4	■ (807)	10	■ (807)	16	■ (502)
5	■ (513)	11	■ (513)		
6	■ (502)	12	■ (502)		

↓ 27.9 mm ↔ 121.9 mm

**No.54** **2 min**



1	■ (079)
2	■ (807)
3	■ (513)
4	■ (502)

↓ 39.8 mm  
↔ 25.6 mm



**6 min**

1	■ (804)	5	■ (513)	9	■ (079)
2	■ (612)	6	■ (502)	10	■ (807)
3	■ (079)	7	■ (804)	11	■ (513)
4	■ (807)	8	■ (612)	12	■ (502)

↓ 23.4 mm ↔ 123.7 mm





No. 58

11 min		
1 (079)	7 (513)	13 (079)
2 (807)	8 (502)	14 (807)
3 (513)	9 (079)	15 (513)
4 (502)	10 (807)	16 (502)
5 (079)	11 (513)	
6 (807)	12 (502)	
↓ 103.6 mm ↔ 94.9 mm		



No.60

4 min	
1 (513)	2 (807)
3 (513)	4 (807)
↓ 106.7 mm	
↔ 93.4 mm	



No.63

1 min
1 (513)
↓ 147.2 mm
↔ 61.8 mm



No.61

3 min	
1 (513)	2 (807)
3 (513)	4 (807)
↓ 42.6 mm	
↔ 142.0 mm	



No.64



No.59

20 min		
1 (079)	17 (513)	33 (804)
2 (807)	18 (502)	34 (612)
3 (804)	19 (079)	35 (513)
4 (612)	20 (807)	36 (502)
5 (513)	21 (804)	37 (079)
6 (502)	22 (612)	38 (807)
7 (079)	23 (513)	39 (804)
8 (807)	24 (502)	40 (612)
9 (804)	25 (079)	41 (513)
10 (612)	26 (807)	42 (502)
11 (513)	27 (804)	43 (079)
12 (502)	28 (612)	44 (807)
13 (079)	29 (513)	45 (804)
14 (807)	30 (502)	46 (612)
15 (804)	31 (079)	47 (513)
16 (612)	32 (807)	48 (502)
↓ 195.4 mm ↔ 157.3 mm		



No.62

11 min		
1 (513)	4 (807)	7 (513)
2 (807)	5 (513)	8 (807)
3 (513)	6 (807)	
↓ 195.4 mm ↔ 158.5 mm		

7 min			
1 (804)	13 (804)	14 (612)	15 (079)
2 (612)	16 (807)	17 (513)	18 (502)
3 (079)	19 (804)	20 (612)	21 (079)
4 (807)	22 (807)	23 (513)	24 (502)
5 (513)	17 (513)		
6 (502)	18 (502)		
7 (804)	19 (804)		
8 (612)	20 (612)		
9 (079)	21 (079)		
10 (807)	22 (807)		
11 (513)	23 (513)		
12 (502)	24 (502)		
↓ 73.3 mm ↔ 72.8 mm			



Embroidery Patterns Color Change Table  
 Tableau de changement de couleur des motifs de broderie  
 Tabella dei cambi colore dei ricami  
 Tabela de alteração de cor do padrão de bordado

Stickdesign-Farbtabelle  
 Kleurenvogorde voor de borduurontwerpen  
 Tabla de cambios de color para diseños de bordado

- Line
- Sierlijk
- Lineare

- Linie
- Fune

- Ligne
- Línea



No.1

L: 13 min S: 9 min	
1	(005)
2	(807)
↓ 125.1 mm	
L:	↔ 103.3 mm
↓ 95.9 mm	
S:	↔ 79.1 mm



No.4

L: 14 min S: 10 min	
1	(005)
2	(807)
↓ 124.8 mm	
L:	↔ 95.8 mm
↓ 95.8 mm	
S:	↔ 73.8 mm



No.7

L: 12 min S: 8 min	
1	(005)
2	(807)
↓ 125.0 mm	
L:	↔ 87.6 mm
↓ 95.8 mm	
S:	↔ 67.2 mm



No.2

L: 13 min S: 9 min	
1	(005)
2	(807)
↓ 124.8 mm	
L:	↔ 86.6 mm
↓ 95.7 mm	
S:	↔ 66.4 mm



No.5

L: 14 min S: 10 min	
1	(005)
2	(807)
↓ 124.8 mm	
L:	↔ 87.8 mm
↓ 95.8 mm	
S:	↔ 67.4 mm

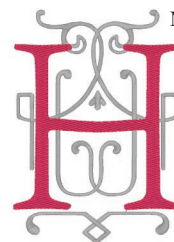

No.8

L: 15 min S: 10 min	
1	(005)
2	(807)
↓ 125.0 mm	
L:	↔ 89.8 mm
↓ 95.7 mm	
S:	↔ 68.8 mm



No.3

L: 11 min S: 8 min	
1	(005)
2	(807)
↓ 124.8 mm	
L:	↔ 85.6 mm
↓ 95.8 mm	
S:	↔ 65.8 mm



No.6

L: 13 min S: 9 min	
1	(005)
2	(807)
↓ 124.8 mm	
L:	↔ 80.6 mm
↓ 95.8 mm	
S:	↔ 61.8 mm



No.9

L: 7 min S: 5 min	
1	(005)
2	(807)
↓ 124.9 mm	
L:	↔ 66.0 mm
↓ 95.8 mm	
S:	↔ 50.6 mm



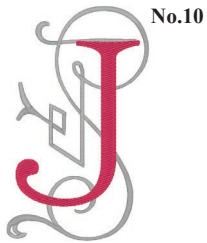

<b>No.10</b>	
L: 9 min S: 6 min	
1	█ (005)
2	█ (807)
↓	124.9 mm
↔	75.4 mm
↓	95.8 mm
↔	57.8 mm



<b>No.13</b>	
L: 18 min S: 13 min	
1	█ (005)
2	█ (807)
↓	125.0 mm
↔	117.6 mm
↓	95.8 mm
↔	90.4 mm



<b>No.16</b>	
L: 13 min S: 9 min	
1	█ (005)
2	█ (807)
↓	125.0 mm
↔	82.6 mm
↓	95.8 mm
↔	63.2 mm



<b>No.11</b>	
L: 13 min S: 9 min	
1	█ (005)
2	█ (807)
↓	125.0 mm
↔	95.6 mm
↓	95.8 mm
↔	73.4 mm



<b>No.14</b>	
L: 15 min S: 10 min	
1	█ (005)
2	█ (807)
↓	124.8 mm
↔	96.0 mm
↓	95.8 mm
↔	73.6 mm



<b>No.17</b>	
L: 15 min S: 10 min	
1	█ (005)
2	█ (807)
↓	124.8 mm
↔	160.4 mm
↓	96.0 mm
↔	123.2 mm



<b>No.12</b>	
L: 12 min S: 9 min	
1	█ (005)
2	█ (807)
↓	124.9 mm
↔	88.1 mm
↓	95.8 mm
↔	67.6 mm



<b>No.15</b>	
L: 13 min S: 9 min	
1	█ (005)
2	█ (807)
↓	124.6 mm
↔	96.8 mm
↓	95.8 mm
↔	74.4 mm



<b>No.18</b>	
L: 11 min S: 7 min	
1	█ (005)
2	█ (807)
↓	124.8 mm
↔	79.6 mm
↓	95.8 mm
↔	61.2 mm



**Embroidery Patterns Color Change Table**  
**Tableau de changement de couleur des motifs de broderie**  
**Tabella dei cambi colore dei ricami**  
**Tabela de alteração de cor do padrão de bordado**

**Stickdesign-Farbtabelle**  
**Kleurenvolgorde voor de borduurontwerpen**  
**Tabla de cambios de color para diseños de bordado**

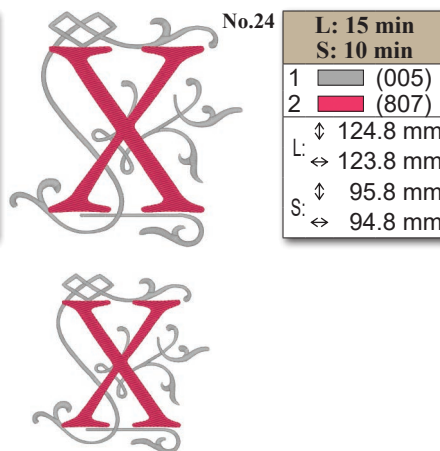
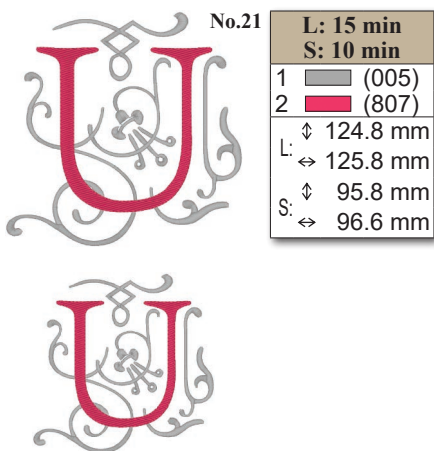
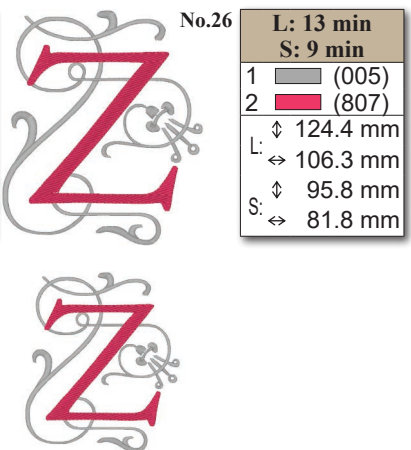
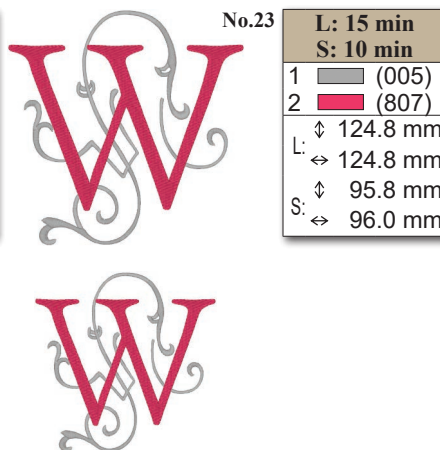
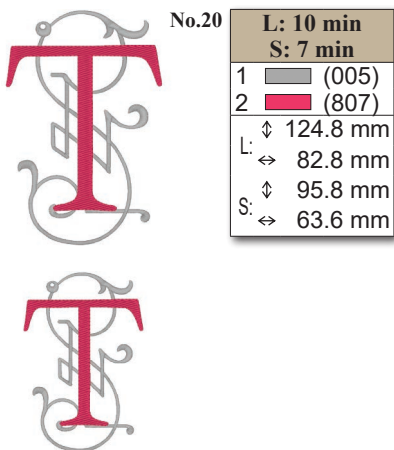
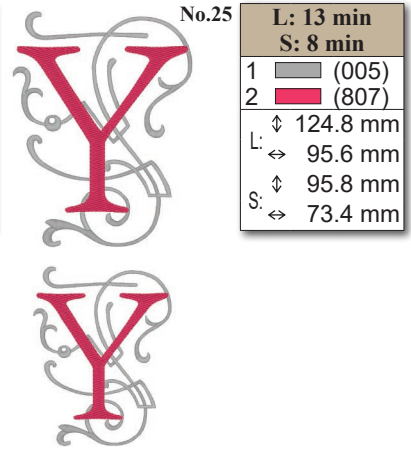
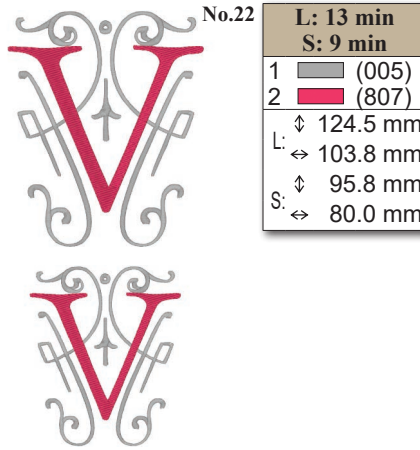
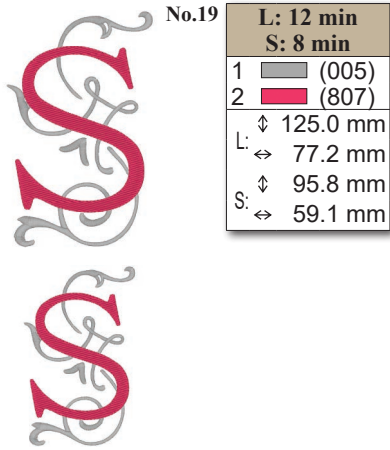

Patterns No.1 - No.26, are designed by Hang to Dry.  
 Designs Nr.1 - Nr.26 wurden von Hang to Dry entworfen.  
 Les motifs n° 1 à 26 sont conçus par Hang to Dry.  
 De ontwerpen 1-26 zijn ontworpen door Hang to Dry.  
 I ricami dal N° 1 al N° 26 sono stati ideati da Hang to Dry.  
 Los diseños del N°1 al N° 26 están diseñados por Hang to Dry.  
 Desenhos N° 1 a N° 26 criados por Hang to Dry.

































- Vine
- Wijnrank
- Videira

- Reben
- Vite

- Vigne
- Vid



<p><b>No.1</b></p>  <p><b>4 min</b></p> <table border="1"> <tr><td>1</td><td>(620)</td></tr> <tr><td>2</td><td>(612)</td></tr> </table> <p>↓ 54.3 mm ↔ 82.8 mm</p>	1	(620)	2	(612)	<p><b>No.9</b></p>  <p><b>3 min</b></p> <table border="1"> <tr><td>1</td><td>(620)</td></tr> <tr><td>2</td><td>(612)</td></tr> </table> <p>↓ 55.0 mm ↔ 68.3 mm</p>	1	(620)	2	(612)	<p><b>No.17</b></p>  <p><b>3 min</b></p> <table border="1"> <tr><td>1</td><td>(620)</td></tr> <tr><td>2</td><td>(612)</td></tr> </table> <p>↓ 54.9 mm ↔ 83.5 mm</p>	1	(620)	2	(612)	<p><b>No.25</b></p>  <p><b>3 min</b></p> <table border="1"> <tr><td>1</td><td>(620)</td></tr> <tr><td>2</td><td>(612)</td></tr> </table> <p>↓ 53.1 mm ↔ 65.9 mm</p>	1	(620)	2	(612)
1	(620)																		
2	(612)																		
1	(620)																		
2	(612)																		
1	(620)																		
2	(612)																		
1	(620)																		
2	(612)																		
<p><b>No.2</b></p>  <p><b>3 min</b></p> <table border="1"> <tr><td>1</td><td>(620)</td></tr> <tr><td>2</td><td>(612)</td></tr> </table> <p>↓ 54.4 mm ↔ 72.6 mm</p>	1	(620)	2	(612)	<p><b>No.10</b></p>  <p><b>3 min</b></p> <table border="1"> <tr><td>1</td><td>(620)</td></tr> <tr><td>2</td><td>(612)</td></tr> </table> <p>↓ 54.3 mm ↔ 71.0 mm</p>	1	(620)	2	(612)	<p><b>No.18</b></p>  <p><b>4 min</b></p> <table border="1"> <tr><td>1</td><td>(620)</td></tr> <tr><td>2</td><td>(612)</td></tr> </table> <p>↓ 54.7 mm ↔ 81.5 mm</p>	1	(620)	2	(612)	<p><b>No.26</b></p>  <p><b>3 min</b></p> <table border="1"> <tr><td>1</td><td>(620)</td></tr> <tr><td>2</td><td>(612)</td></tr> </table> <p>↓ 55.9 mm ↔ 70.0 mm</p>	1	(620)	2	(612)
1	(620)																		
2	(612)																		
1	(620)																		
2	(612)																		
1	(620)																		
2	(612)																		
1	(620)																		
2	(612)																		
<p><b>No.3</b></p>  <p><b>3 min</b></p> <table border="1"> <tr><td>1</td><td>(620)</td></tr> <tr><td>2</td><td>(612)</td></tr> </table> <p>↓ 53.9 mm ↔ 73.3 mm</p>	1	(620)	2	(612)	<p><b>No.11</b></p>  <p><b>3 min</b></p> <table border="1"> <tr><td>1</td><td>(620)</td></tr> <tr><td>2</td><td>(612)</td></tr> </table> <p>↓ 55.2 mm ↔ 85.3 mm</p>	1	(620)	2	(612)	<p><b>No.19</b></p>  <p><b>3 min</b></p> <table border="1"> <tr><td>1</td><td>(620)</td></tr> <tr><td>2</td><td>(612)</td></tr> </table> <p>↓ 54.5 mm ↔ 73.8 mm</p>	1	(620)	2	(612)	<p><b>No.27</b></p>  <p><b>3 min</b></p> <table border="1"> <tr><td>1</td><td>(620)</td></tr> <tr><td>2</td><td>(612)</td></tr> </table> <p>↓ 57.4 mm ↔ 57.7 mm</p>	1	(620)	2	(612)
1	(620)																		
2	(612)																		
1	(620)																		
2	(612)																		
1	(620)																		
2	(612)																		
1	(620)																		
2	(612)																		
<p><b>No.4</b></p>  <p><b>4 min</b></p> <table border="1"> <tr><td>1</td><td>(620)</td></tr> <tr><td>2</td><td>(612)</td></tr> </table> <p>↓ 54.6 mm ↔ 80.0 mm</p>	1	(620)	2	(612)	<p><b>No.12</b></p>  <p><b>3 min</b></p> <table border="1"> <tr><td>1</td><td>(620)</td></tr> <tr><td>2</td><td>(612)</td></tr> </table> <p>↓ 53.9 mm ↔ 75.0 mm</p>	1	(620)	2	(612)	<p><b>No.20</b></p>  <p><b>3 min</b></p> <table border="1"> <tr><td>1</td><td>(620)</td></tr> <tr><td>2</td><td>(612)</td></tr> </table> <p>↓ 54.2 mm ↔ 73.2 mm</p>	1	(620)	2	(612)	<p><b>No.28</b></p>  <p><b>3 min</b></p> <table border="1"> <tr><td>1</td><td>(620)</td><td>2</td><td>(612)</td></tr> </table> <p>↓ 31.5 mm ↔ 119.2 mm</p>	1	(620)	2	(612)
1	(620)																		
2	(612)																		
1	(620)																		
2	(612)																		
1	(620)																		
2	(612)																		
1	(620)	2	(612)																
<p><b>No.5</b></p>  <p><b>3 min</b></p> <table border="1"> <tr><td>1</td><td>(620)</td></tr> <tr><td>2</td><td>(612)</td></tr> </table> <p>↓ 55.0 mm ↔ 65.3 mm</p>	1	(620)	2	(612)	<p><b>No.13</b></p>  <p><b>4 min</b></p> <table border="1"> <tr><td>1</td><td>(620)</td></tr> <tr><td>2</td><td>(612)</td></tr> </table> <p>↓ 54.1 mm ↔ 85.0 mm</p>	1	(620)	2	(612)	<p><b>No.21</b></p>  <p><b>3 min</b></p> <table border="1"> <tr><td>1</td><td>(620)</td></tr> <tr><td>2</td><td>(612)</td></tr> </table> <p>↓ 53.6 mm ↔ 78.3 mm</p>	1	(620)	2	(612)	<p><b>No.29</b></p>  <p><b>2 min</b></p> <table border="1"> <tr><td>1</td><td>(620)</td><td>2</td><td>(612)</td></tr> </table> <p>↓ 13.4 mm ↔ 195.4 mm</p>	1	(620)	2	(612)
1	(620)																		
2	(612)																		
1	(620)																		
2	(612)																		
1	(620)																		
2	(612)																		
1	(620)	2	(612)																
<p><b>No.6</b></p>  <p><b>3 min</b></p> <table border="1"> <tr><td>1</td><td>(620)</td></tr> <tr><td>2</td><td>(612)</td></tr> </table> <p>↓ 54.0 mm ↔ 78.8 mm</p>	1	(620)	2	(612)	<p><b>No.14</b></p>  <p><b>3 min</b></p> <table border="1"> <tr><td>1</td><td>(620)</td></tr> <tr><td>2</td><td>(612)</td></tr> </table> <p>↓ 54.6 mm ↔ 84.8 mm</p>	1	(620)	2	(612)	<p><b>No.22</b></p>  <p><b>3 min</b></p> <table border="1"> <tr><td>1</td><td>(620)</td></tr> <tr><td>2</td><td>(612)</td></tr> </table> <p>↓ 53.1 mm ↔ 70.9 mm</p>	1	(620)	2	(612)					
1	(620)																		
2	(612)																		
1	(620)																		
2	(612)																		
1	(620)																		
2	(612)																		
<p><b>No.7</b></p>  <p><b>3 min</b></p> <table border="1"> <tr><td>1</td><td>(620)</td></tr> <tr><td>2</td><td>(612)</td></tr> </table> <p>↓ 54.6 mm ↔ 70.4 mm</p>	1	(620)	2	(612)	<p><b>No.15</b></p>  <p><b>3 min</b></p> <table border="1"> <tr><td>1</td><td>(620)</td></tr> <tr><td>2</td><td>(612)</td></tr> </table> <p>↓ 53.9 mm ↔ 78.7 mm</p>	1	(620)	2	(612)	<p><b>No.23</b></p>  <p><b>4 min</b></p> <table border="1"> <tr><td>1</td><td>(620)</td></tr> <tr><td>2</td><td>(612)</td></tr> </table> <p>↓ 53.4 mm ↔ 82.6 mm</p>	1	(620)	2	(612)	<p><b>No.1</b></p>  <p><b>4 min</b></p> <table border="1"> <tr><td>1</td><td>(620)</td></tr> <tr><td>2</td><td>(612)</td></tr> </table> <p>↓ 54.3 mm ↔ 82.8 mm</p>	1	(620)	2	(612)
1	(620)																		
2	(612)																		
1	(620)																		
2	(612)																		
1	(620)																		
2	(612)																		
1	(620)																		
2	(612)																		
<p><b>No.8</b></p>  <p><b>4 min</b></p> <table border="1"> <tr><td>1</td><td>(620)</td></tr> <tr><td>2</td><td>(612)</td></tr> </table> <p>↓ 54.3 mm ↔ 83.3 mm</p>	1	(620)	2	(612)	<p><b>No.16</b></p>  <p><b>3 min</b></p> <table border="1"> <tr><td>1</td><td>(620)</td></tr> <tr><td>2</td><td>(612)</td></tr> </table> <p>↓ 54.7 mm ↔ 67.2 mm</p>	1	(620)	2	(612)	<p><b>No.24</b></p>  <p><b>3 min</b></p> <table border="1"> <tr><td>1</td><td>(620)</td></tr> <tr><td>2</td><td>(612)</td></tr> </table> <p>↓ 53.2 mm ↔ 83.4 mm</p>	1	(620)	2	(612)					
1	(620)																		
2	(612)																		
1	(620)																		
2	(612)																		
1	(620)																		
2	(612)																		



**Embroidery Patterns Color Change Table**  
**Tableau de changement de couleur des motifs de broderie**  
**Tabella dei cambi colore dei ricami**  
**Tabela de alteração de cor do padrão de bordado**

**Stickdesign-Farbtabelle**  
**Kleurenvolgorde voor de borduurentwerpen**  
**Tabla de cambios de color para diseños de bordado**

- Appliqué alphabet
- Applicatie lettertype
- Alfabeto para apliques

- Buchstabenapplikationen
- Alabeto in appliqué

- Alphabet d'appliqués
- Diseños alfabéticos con adornos



\* Approximate size/Ungefähre Größe/Taille approximative/Afmeting (ongeveer)/  
 Dimensioni approssimative/Tamaño aproximado/Tamanho aproximado

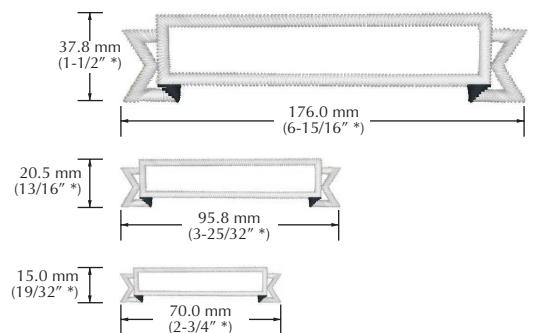
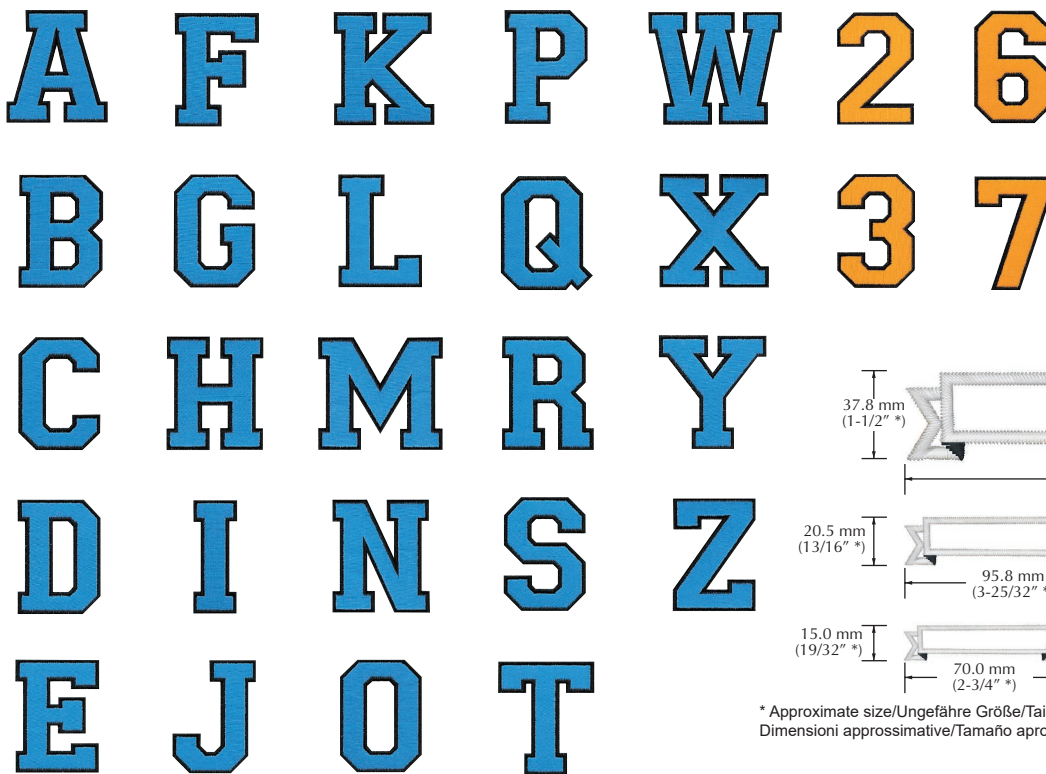

\* Approximate size/Ungefähre Größe/Taille approximative/Afmeting (ongeveer)/  
 Dimensioni approssimative/Tamaño aproximado/Tamanho aproximado

- ♥ Refer to the operation manual for the embroidery machine for details on how to embroider appliqués.
- ♥ Weitere Hinweise zum Stickten von Applikationen finden Sie in der Bedienungsanleitung der Stickmaschine.
- ♥ Reportez-vous au manuel d'instructions de la machine à broder pour plus d'informations sur la broderie des appliqués.
- ♥ Raadpleeg de bedieningshandleiding bij de borduurmachine voor gedetailleerde uitleg over het borduren van applicaties.
- ♥ Consultare il manuale di istruzioni della macchina per ricamare per i dettagli relativi al ricamo in appliqué.
- ♥ Consulte el manual de instrucciones de la máquina de bordar si desea más información sobre cómo bordar apliques.
- ♥ Consulte o manual de operações da máquina de bordar para obter detalhes sobre como bordar apliques.

- Appliqué Greek alphabet
- Grieks applicatie lettertype
- Alfabeto grego para apliques

- Griechische Buchstaben für Applikationen
- Alfabeto greco in appliqué

- Alphabet grec d'appliqués
- Alfabeto griego con adornos



<p><b>No.1</b></p> <p><b>3 min</b></p> <p>1 -----x (420) 2 ----- (420) 3 ----- (509) 4 ----- (509)</p> <p>↓ 77.8 mm ↔ 80.4 mm</p>	<p><b>No.7</b></p> <p><b>5 min</b></p> <p>1 -----x (420) 2 ----- (420) 3 ----- (509) 4 ----- (509)</p> <p>↓ 75.9 mm ↔ 78.5 mm</p>	<p><b>No.13</b></p> <p><b>4 min</b></p> <p>1 -----x (420) 2 ----- (420) 3 ----- (509) 4 ----- (509)</p> <p>↓ 78.3 mm ↔ 78.4 mm</p>	<p><b>No.19</b></p> <p><b>3 min</b></p> <p>1 -----x (420) 2 ----- (420) 3 ----- (509) 4 ----- (509)</p> <p>↓ 76.1 mm ↔ 68.0 mm</p>
<p><b>No.2</b></p> <p><b>4 min</b></p> <p>1 -----x (420) 2 ----- (420) 3 ----- (509) 4 ----- (509)</p> <p>↓ 76.0 mm ↔ 70.7 mm</p>	<p><b>No.8</b></p> <p><b>5 min</b></p> <p>1 -----x (420) 2 ----- (420) 3 ----- (509) 4 ----- (509)</p> <p>↓ 80.2 mm ↔ 73.9 mm</p>	<p><b>No.14</b></p> <p><b>5 min</b></p> <p>1 -----x (420) 2 ----- (420) 3 ----- (509) 4 ----- (509)</p> <p>↓ 76.1 mm ↔ 68.5 mm</p>	<p><b>No.20</b></p> <p><b>3 min</b></p> <p>1 -----x (420) 2 ----- (420) 3 ----- (509) 4 ----- (509)</p> <p>↓ 75.9 mm ↔ 79.1 mm</p>
<p><b>No.3</b></p> <p><b>3 min</b></p> <p>1 -----x (420) 2 ----- (420) 3 ----- (509) 4 ----- (509)</p> <p>↓ 76.0 mm ↔ 68.2 mm</p>	<p><b>No.9</b></p> <p><b>2 min</b></p> <p>1 -----x (420) 2 ----- (420) 3 ----- (509) 4 ----- (509)</p> <p>↓ 76.0 mm ↔ 38.1 mm</p>	<p><b>No.15</b></p> <p><b>3 min</b></p> <p>1 -----x (420) 2 ----- (420) 3 ----- (509) 4 ----- (509)</p> <p>↓ 80.3 mm ↔ 73.9 mm</p>	<p><b>No.21</b></p> <p><b>5 min</b></p> <p>1 -----x (420) 2 ----- (420) 3 ----- (509) 4 ----- (509)</p> <p>↓ 75.9 mm ↔ 78.0 mm</p>
<p><b>No.4</b></p> <p><b>3 min</b></p> <p>1 -----x (420) 2 ----- (420) 3 ----- (509) 4 ----- (509)</p> <p>↓ 77.7 mm ↔ 70.0 mm</p>	<p><b>No.10</b></p> <p><b>4 min</b></p> <p>1 -----x (420) 2 ----- (420) 3 ----- (509) 4 ----- (509)</p> <p>↓ 76.1 mm ↔ 80.5 mm</p>	<p><b>No.16</b></p> <p><b>4 min</b></p> <p>1 -----x (420) 2 ----- (420) 3 ----- (509) 4 ----- (509)</p> <p>↓ 75.9 mm ↔ 82.6 mm</p>	<p><b>No.22</b></p> <p><b>4 min</b></p> <p>1 -----x (420) 2 ----- (420) 3 ----- (509) 4 ----- (509)</p> <p>↓ 76.0 mm ↔ 80.8 mm</p>
<p><b>No.5</b></p> <p><b>4 min</b></p> <p>1 -----x (420) 2 ----- (420) 3 ----- (509) 4 ----- (509)</p> <p>↓ 76.1 mm ↔ 69.8 mm</p>	<p><b>No.11</b></p> <p><b>3 min</b></p> <p>1 -----x (420) 2 ----- (420) 3 ----- (509) 4 ----- (509)</p> <p>↓ 78.0 mm ↔ 76.0 mm</p>	<p><b>No.17</b></p> <p><b>3 min</b></p> <p>1 -----x (420) 2 ----- (420) 3 ----- (509) 4 ----- (509)</p> <p>↓ 76.0 mm ↔ 62.0 mm</p>	<p><b>No.23</b></p> <p><b>4 min</b></p> <p>1 -----x (420) 2 ----- (420) 3 ----- (509) 4 ----- (509)</p> <p>↓ 76.0 mm ↔ 86.7 mm</p>
<p><b>No.6</b></p> <p><b>3 min</b></p> <p>1 -----x (420) 2 ----- (420) 3 ----- (509) 4 ----- (509)</p> <p>↓ 76.0 mm ↔ 67.4 mm</p>	<p><b>No.12</b></p> <p><b>5 min</b></p> <p>1 -----x (420) 2 ----- (420) 3 ----- (509) 4 ----- (509)</p> <p>↓ 76.0 mm ↔ 95.3 mm</p>	<p><b>No.18</b></p> <p><b>4 min</b></p> <p>1 -----x (420) 2 ----- (420) 3 ----- (509) 4 ----- (509)</p> <p>↓ 76.0 mm ↔ 69.0 mm</p>	<p><b>No.24</b></p> <p><b>5 min</b></p> <p>1 -----x (420) 2 ----- (420) 3 ----- (509) 4 ----- (509)</p> <p>↓ 78.0 mm ↔ 74.1 mm</p>

- Refer to the operation manual for the embroidery machine for details on how to embroider appliqués.
- Weitere Hinweise zum Sticken von Applikationen finden Sie in der Bedienungsanleitung der Stickmaschine.
- Reportez-vous au manuel d'instructions de la machine à broder pour plus d'informations sur la broderie des appliqués.
- Raadpleeg de bedieningshandleiding bij de borduurmachine voor gedetailleerde uitleg over het borduren van applicaties.
- Consultare il manuale di istruzioni della macchina per ricamare per i dettagli relativi al ricamo in appliqué.
- Consulte el manual de instrucciones de la máquina de bordar si desea más información sobre cómo bordar apliques.
- Consulte o manual de operações da máquina de bordar para obter detalhes sobre como bordar apliques.

- ✦ Monograms
- ✦ Monogrammes
- ✦ Monogrammi
- ✦ Monogramas
- ✦ Monogramme
- ✦ Monogrammen
- ✦ Monogramas

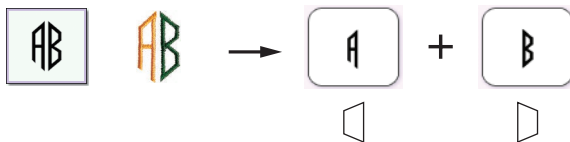
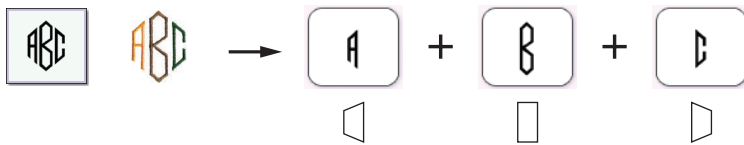

- Monogram Frames
- Monogramkaders en omrandingen
- Molduras de monograma
- Monogrammrahmen
- Cornici per monogramma
- Encadrements pour monogrammes
- Costuras de encuadre con texto de monograma

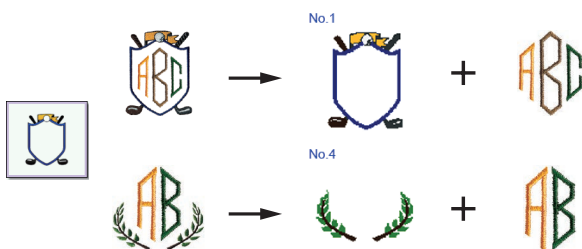

❖ Monogram Frames

❖ Encadrements pour monogrammes

❖ Cornici per monogramma

❖ Molduras de monograma

❖ Monogrammrahmen

❖ Monogramkaders en omrandingen

❖ Costuras de encuadre con texto de monograma



No.1

L:	5 min
M:	3 min
S:	2 min
1	(001)
2	(058)
3	(208)
4	(707)
5	(007)
↓	94.4 mm
L:	↔ 73.6 mm
↓	64.1 mm
M:	↔ 50.1 mm
↓	40.9 mm
S:	↔ 31.2 mm

No.4

L:	2 min
M:	1 min
S:	1 min
1	(515)
2	(058)
↓	48.4 mm
L:	↔ 92.5 mm
↓	31.2 mm
M:	↔ 59.5 mm
↓	19.1 mm
S:	↔ 36.4 mm

No.7

L:	2 min
M:	1 min
S:	1 min
1	(214)
2	(843)
↓	84.8 mm
L:	↔ 84.8 mm
↓	55.0 mm
M:	↔ 54.9 mm
↓	33.9 mm
S:	↔ 33.9 mm

No.2

L:	5 min
M:	3 min
S:	2 min
1	(001)
2	(513)
3	(208)
4	(007)
5	(900)
↓	90.1 mm
L:	↔ 81.6 mm
↓	60.2 mm
M:	↔ 54.9 mm
↓	38.8 mm
S:	↔ 36.1 mm

No.5

L:	1 min
M:	1 min
S:	1 min
1	(205)
2	(085)
3	(612)
4	(800)
↓	92.5 mm
L:	↔ 78.9 mm
↓	59.6 mm
M:	↔ 50.9 mm
↓	34.9 mm
S:	↔ 29.7 mm

No.8

L:	2 min
M:	1 min
S:	1 min
1	(507)
2	(800)
↓	94.9 mm
L:	↔ 94.4 mm
↓	63.6 mm
M:	↔ 63.9 mm
↓	39.9 mm
S:	↔ 40.2 mm

No.3

L:	3 min
M:	2 min
S:	1 min
1	(323)
↓	93.8 mm
L:	↔ 64.5 mm
↓	61.4 mm
M:	↔ 42.6 mm
↓	40.3 mm
S:	↔ 27.5 mm

No.6

L:	3 min
M:	1 min
S:	1 min
1	(328)
↓	77.5 mm
L:	↔ 78.2 mm
↓	50.0 mm
M:	↔ 50.4 mm
↓	29.7 mm
S:	↔ 29.9 mm

No.9

L:	3 min
M:	1 min
S:	1 min
1	(900)
2	(515)
3	(214)
↓	94.6 mm
L:	↔ 72.3 mm
↓	59.5 mm
M:	↔ 46.0 mm
↓	37.2 mm
S:	↔ 28.8 mm



**Embroidery Patterns Color Change Table**  
**Tableau de changement de couleur des motifs de broderie**  
**Tabella dei cambi colore dei ricami**  
**Tabela de alteração de cor do padrão de bordado**

**Stickdesign-Farbtabelle**  
**Kleurenvolgorde voor de borduurontwerpen**  
**Tabla de cambios de color para diseños de bordado**

No.10

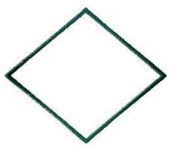

L: 2 min	M: 1 min	S: 1 min
1	■ (534)	
↓	83.4 mm	
L:	↔ 98.7 mm	
↓	56.1 mm	
M:	↔ 66.8 mm	
↓	35.1 mm	
S:	↔ 41.8 mm	

No.12



L: 1 min	M: 1 min	S: 1 min
1	■ (070)	
2	■ (612)	
↓	22.7 mm	
L:	↔ 90.0 mm	
↓	14.5 mm	
M:	↔ 57.4 mm	
↓	8.9 mm	
S:	↔ 34.6 mm	

No.14



L: 1 min	M: 1 min	S: 1 min
1	■ (800)	
↓	24.4 mm	
L:	↔ 88.1 mm	
↓	15.1 mm	
M:	↔ 56.7 mm	
↓	8.4 mm	
S:	↔ 38.9 mm	

No.11



L: 1 min	M: 1 min	S: 1 min
1	■ (620)	
↓	25.2 mm	
L:	↔ 89.4 mm	
↓	16.8 mm	
M:	↔ 57.4 mm	
↓	9.1 mm	
S:	↔ 34.0 mm	

No.13



L: 1 min	M: 1 min	S: 1 min
1	■ (208)	
↓	28.3 mm	
L:	↔ 91.4 mm	
↓	18.4 mm	
M:	↔ 59.0 mm	
↓	11.4 mm	
S:	↔ 36.1 mm	

No.15



L: 2 min	M: 1 min	S: 1 min
1	■ (214)	
2	■ (058)	
↓	24.3 mm	
L:	↔ 54.4 mm	
↓	15.5 mm	
M:	↔ 34.7 mm	
↓	9.3 mm	
S:	↔ 20.8 mm	

# Examples of Combinations Exemples de combinaisons Esempi di combinazioni Exemplos de combinações

# Kombinationsbeispiele Voorbeelden van combinaties Ejemplos de combinaciones

- Embroidery patterns on these pages are illustration images, which may be different from the patterns in your machine.
- Les motifs de broderie figurant sur ces pages sont des images d'illustration qui peuvent différer des motifs proposés par votre machine.
- I ricami di queste pagine sono immagini a scopo illustrativo, che potrebbero differire dai ricami della macchina.
- Os padrões de bordado nestas páginas são imagens ilustrativas, que podem ser diferentes dos padrões em sua máquina.
- Die auf diesen Seiten abgebildeten Stickmuster dienen nur der Illustration; sie können von den Mustern in Ihrer Maschine abweichen.
- De weergegeven borduurpatronen in deze illustraties dienen als voorbeeld. Het is mogelijk dat ze af wijken van de borduurpatronen in de machine.
- Los diseños de bordado de estas páginas son ilustraciones, que pueden ser diferentes de los diseños de la máquina.



No.3 +



No.4 +



No.5 = (900)



No.3 + No.5 × 2



No.16 × 2 + No.17 × 2



No.8 + No.9 × 2



No.3 × 2

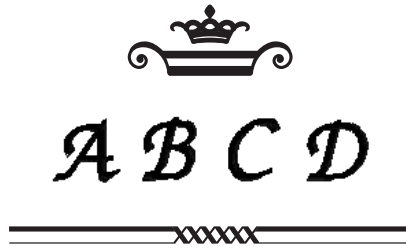
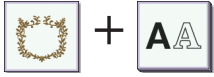

No.14 + No.15



No.12 × 2

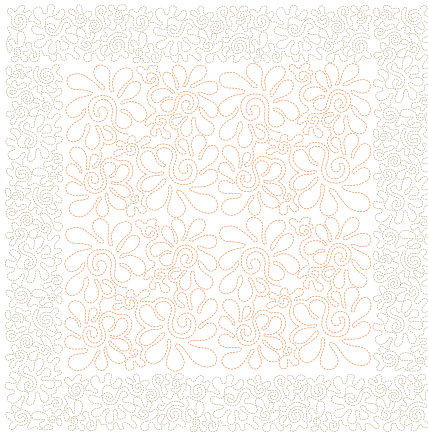

No.2 × 4 + No.14 × 12

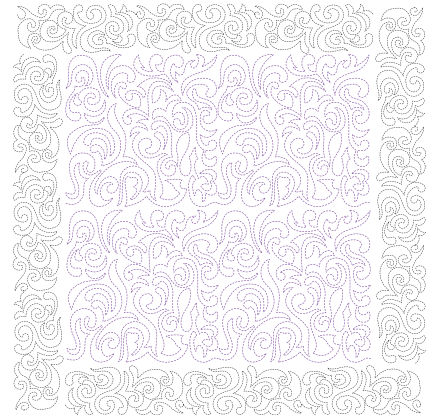

No.8 × 4 + No.16 × 12

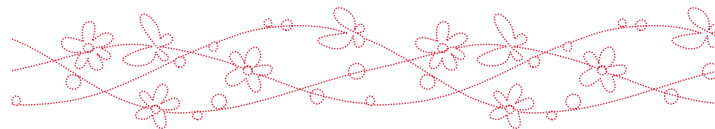

No.17 × 2



No.2 + No.27 × 2



No.6 + No.10 + No.19



No.2 + No.28 × 2

# Create 3D embroidery Créer une broderie 3D Creare ricami 3D Criar bordados 3D

# Erstellen von 3D-Stickereien Creëer 3D-borduurwerk Crear bordados en 3D

You can make 3D embroidery by using urethane foam for embroidery. Refer to the operation manual for the embroidery machine for details on how to embroider 3D font.

Vous pouvez créer une broderie 3D en utilisant de la mousse puffy pour la broderie. Reportez-vous au manuel d'instructions de la machine à broder pour plus d'informations sur la broderie des polices 3D.

Puoi realizzare ricami in 3D utilizzando la gommina o schiuma di poliuretano per ricamo. Consulta il manuale di istruzioni della macchina per ricamare per sapere come realizzare i caratteri 3D.

Você pode fazer bordados 3D usando espuma de uretano para bordar. Consulte o Manual de Operações da máquina de bordar para saber mais sobre como bordar fontes 3D.

Zum Sticken von 3D-Stickereien können Sie Moosgummi verwenden. Weitere Hinweise zum Sticken von 3D-Schriftarten finden Sie in der Bedienungsanleitung der Stickmaschine.

Creëer 3D-borduurwerk met gebruik van foam-materialen. Raadpleeg de bedieningshandleiding bij de borduurmachine voor gedetailleerde uitleg over het borduren van 3D-lettertypen.

Puede realizar bordados en 3D utilizando espuma de uretano para bordar. Consulte el manual de instrucciones de la máquina de bordar si desea más información sobre cómo bordar el tipo de letra 3D.

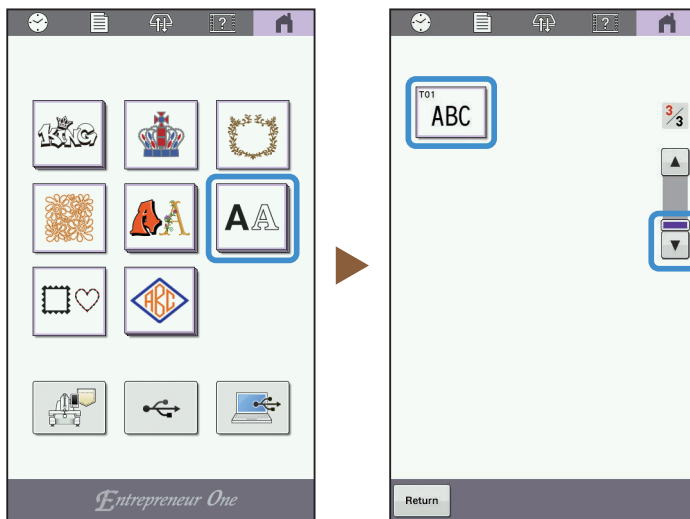

Instruction Video  
Anleitungsvideo  
Vidéo d'instructions  
Instructievideo  
Video con istruzioni  
Vidéo de instrucciones  
Vidéo de instruções



<https://s.brother/cvcab/>

\* We recommend that flat brim cap frame (sold separately) be used for embroidering caps. Visit our website <https://s.brother/cocab/> .

\* Zum Besticken von Kappen empfehlen wir die Verwendung des flachen Kappenrahmens (separat erhältlich). Besuchen Sie unsere Website <https://s.brother/cocab/> .

\* Nous recommandons d'utiliser le cadre à broder pour casquette à bord plat (vendu séparément) pour broder des casquettes. Visitez notre site Web <https://s.brother/cocab/> .

\* We adviseren om een "Pettenframe voor diverse pet modellen" (afzonderlijk verkrijgbaar) te gebruiken voor het borduren van petten. Ga naar onze website <https://s.brother/cocab/> .

\* Si consiglia di utilizzare il telaio per cappelli con visiera piatta (venduto separatamente) per ricamare i cappelli. Visitare il nostro sito Web <https://s.brother/cocab/> .

\* Recomendamos utilizar el bastidor para gorras (no incluido) para bordar gorras. Visite nuestro sitio web <https://s.brother/cocab/> .

\* Recomendamos que o bastidor para bonés de aba reta (vendido separadamente) seja usado para bordar bonés. Visite nosso site <https://s.brother/cocab/> .



Font Name Chart  
 Tableau des noms de polices  
 Tabella nomi dei font  
 Quadro de nomes de fontes

Tabelle der Schriftarten  
 Overzicht lettertypen  
 Diagrama de nombre de las fuentes

1		Künstlerschreibschrift
2		Block 01
3		Serif 01
4		Brussels Demi Outline
5		Tennessee ExtraBold
6		Brussels Light
7		Serif 02
8		Calgary MediumItalic
9		Maryland
10		Vermont
11		Dalliance Script
12		Sicilia Light Italic (Sicilia)
13		Luedickital
14		Toms Handwritten
15		Bergen
16		Tirol
17		Istanbul
18		San Diego

19		Los Angeles
20		Saipan
21		Gothic 01
22		Bayern Book
23		Florida Medium
24		Lillehammer
25		Dalliance Roman
26		Helsinki Nallow S*
27		Riesa S*
28		Germany S*
29		Script 01 SR*
30		Block 01*
31		Utah Bold Cyrillic
32		PC Tennessee Bold Cyrillic
33		Letter Gothic Bold

- \*Small font
- \*Kleine Schriftart
- \*Petite police
- \*Klein lettertype
- \*Font piccolo
- \*Tipo de letra pequeña
- \*Fonte pequena





English  
German  
French  
Dutch  
Italian  
Spanish  
Portuguese-BR

882-T52



D02R4U-001